

Panasonic®

OPERATING INSTRUCTIONS Tablet Computer

Model No. **JT-B1** series

Read Me First

Getting Started

Using

Troubleshooting

Appendix

For further information about this computer, you can refer to the on-screen manual by performing the following steps.

Touch – [OnlineManual] (referred to as “Reference Manual”).

When more than one on-screen manuals are prepared, name of those manuals are listed in above step. Touch a manual to access from the list.

Contents

Read Me First

Safety precautions.....	2
Regulatory information	10

Getting Started

Handling and maintenance.....	18
Introduction.....	21
Confirmation of accessories	22
Description of parts.....	23

Using

Input operation.....	27
Turning on/off and sleeping/waking up	28
First-time operation.....	29
How to attach the hand strap.....	33
How to change the battery pack.....	34
Installing and removing the microSIM card	36
Installing and removing the microSD memory card.....	37

Troubleshooting

Troubleshooting (basic).....	38
------------------------------	----

Appendix

Specifications	41
Options	44
LIMITED WARRANTY.....	45



Thank you for purchasing this Panasonic product.

Please read these instructions carefully before using this product, and save this manual for future use.

Safety precautions

To reduce the risk of injury, loss of life, electric shock, fire, malfunction, and damage to equipment or property, always observe the following safety precautions.

Explanation of symbol word panels

The following symbol word panels are used to classify and describe the level of hazard, injury, and property damage caused when the denotation is disregarded and improper use is performed.



	DANGER
Denotes a potential hazard that will result in serious injury or death.	

	WARNING
Denotes a potential hazard that could result in serious injury or death.	





	CAUTION
Denotes a hazard that could result in minor injury.	







NOTICE
Denotes a hazard that could result in property damage.





The following symbols are used to classify and describe the type of instructions to be observed.

	This symbol is used to alert users to a specific operating procedure that must not be performed.
	This symbol is used to alert users to a specific operating procedure that must be followed in order to operate the unit safely.

Tablet computer







 WARNING	
	Use the dedicated AC adaptor (JT-B1-AD000U). Generation of heat, ignition or rupture of the product may result.
	Do not disassemble this product. You may receive an electric shock, or foreign matter may enter and result in a fire.
	Do not insert foreign objects. Doing so may cause the battery to short-circuit or generate heat, possibly resulting in a fire and/or electric shocks.
	If a malfunction or trouble occurs, immediately stop use. If a malfunction occurs, immediately unplug the AC plug. <ul style="list-style-type: none"> • This product is damaged • Water or foreign objects have found their way inside the product • Smoke emitted • Abnormal odors or sounds are being emitted • Unusually hot Continuing to use this product while any of the above conditions are present may result in fire or electric shock. <ul style="list-style-type: none"> • If a malfunction or trouble occurs, immediately turn the power off and unplug the AC plug. Then contact your technical support office for repair.



 WARNING	
	<p>Do not turn the volume up to loud when using headphones. Listening at high volumes that overstimulate the ear for long periods of time may result in loss of hearing.</p>
	<p>Do not touch this product and cable when it starts thundering. Electric shock may result.</p>
	<p>Close the connector cover tightly when using this product where is a lot of water, moisture, steam, dust, oily vapors, etc. The entry of foreign matter may cause a fire or electric shocks.</p> <ul style="list-style-type: none"> • If foreign matter has found its way inside, immediately turn the power off and unplug the AC cord. Then contact your technical support office.
	<p>Keep microSD memory cards away from infants and small children. Accidental swallowing will result in bodily injury.</p> <ul style="list-style-type: none"> • In the event of accidental swallowing, see a doctor immediately.
	<p>Keep microSIM cards away from infants and small children. Accidental swallowing will result in bodily injury.</p> <ul style="list-style-type: none"> • In the event of accidental swallowing, see a doctor immediately.

	<p>Do not use with exposing the skin to this product for a long period of time. Using this product with exposing the skin to the heat source of this product or AC adaptor for a long period of time can cause a low-temperature burn.</p>
	<p>Do not operate this product during walking, bicycle riding, or car driving. There is the risk of falling or a traffic accident.</p>
	<p>Do not use this equipment close to an automatic control equipment like an automatic door fire alarm and so on. Radio waves from this equipment may cause the trouble by a malfunction for automatic equipment.</p>
	<p>Do not use headphones while you are driving or in other situations where your inability to hear the sounds around you is potentially dangerous. Otherwise, you may have an accident. Take special care at level crossings, on station platforms, roads, construction sites, etc.</p>







Safety precautions





Tablet computer (continued)

 CAUTION	
	<p>Do not place this product on unstable surfaces. If balance is lost, this product may fall over or drop, resulting in an injury.</p>
	<p>Take a break of 10-15 minutes every hour. Using this product for long periods of time may have detrimental health effects on the eyes or hands.</p>
	<p>Do not move this product while the AC plug is connected. The AC cord may be damaged, resulting in fire or electric shock.</p> <ul style="list-style-type: none"> • If the AC cord is damaged, unplug the AC plug immediately.
	<p>Do not splash water on the tablet computer or moisten the tablet computer with water. There is the risk of heat generation, fire, or explosion.</p>
	<p>Turn down the volume of the headphones before connecting the headphones. If you connect the headphones with the volume turned up way too much, your ears will be suddenly exposed to a high-volume sound which may damage your hearing.</p> <ul style="list-style-type: none"> • Turn up the volume little by little.
	<p>Avoid stacking. If balance is lost, this product may fall over or drop, resulting in an injury.</p>

	<p>Do not leave this product in high temperature environment for a long period of time. Leaving this product where it will be exposed to extremely high temperatures such as near fire or in direct sunlight may deform the cabinet and/or cause trouble in the internal parts. Continued use in such a resulting condition may lead to short-circuiting or insulation defects, etc. which may in turn lead to a fire or electric shocks.</p>
	<p>Do not expose the skin to this product when using the product in a hot or cold environment. Burns, low-temperature burns, or frostbite may result.</p> <ul style="list-style-type: none"> • When it is necessary to expose the skin to this product such as to scan a fingerprint, perform the operation in the shortest time possible.
	<p>Do not look directly into the camera light or point it at other people's eyes. Looking directly at the white light for prolonged periods of time may damage your eyes.</p>







■ Battery pack (JT-B1-BT000U)





 DANGER	
	<p>This rechargeable battery is for use solely with the designated product. Do not use it for any other products. Generation of heat, ignition or rupture of the battery may result.</p>
	<p>Do not insert sharp objects into the internal battery, disassemble, or modify it. Electrolyte leakage, generation of heat, ignition or rupture of the battery may result.</p>
	<p>Do not short positive (+) and negative (-) contact. Do not carry it around or store it together with necklaces, hairpins, etc. Generation of heat, ignition or rupture of the battery may result.</p>
	<p>Do not throw the product into a fire or expose it to excessive heat. Generation of heat, ignition or rupture of the battery may result.</p>
	<p>Avoid extreme heat (near the fire, in direct sunlight, for example). Electrolyte leakage, generation of heat, ignition or rupture of the battery may result.</p>
	<p>Use the dedicated charger. Generation of heat, ignition or rupture of the battery may result.</p>







 WARNING	
	<p>Do not splash water on the battery pack or moisten the battery pack with water. Generation of heat, ignition or rupture of the battery may result.</p>
	<p>If the battery pack leaks liquid or smells, do not bring the battery pack close to fire. Generation of heat, ignition or rupture of the battery may result.</p>
	<p>Do not touch the electrolyte leaked from the battery pack. If electrolyte gets on your body or clothing, rinse it off thoroughly with water. Entry of the electrolyte into an eye may lead to blindness. In such a case, rinse the affected eye thoroughly with clean water, and then seek medical attention immediately.</p>

Safety precautions

AC adaptor (JT-B1-AD000U)

 WARNING	
	<p>Do not do anything that may damage the AC cord, the AC plug, or the AC adaptor. Do not damage or modify the cord, place it near hot tools, bend, twist, or pull it forcefully, place heavy objects on it, or bundle it tightly. Continuing to use a damaged cord may result in fire, short circuit, or electric shock.</p>
	<p>Do not move this product while the AC plug is connected. The AC cord may be damaged, resulting in fire or electric shock. • If the AC cord is damaged, unplug the AC plug immediately.</p>
	<p>This AC adaptor is for use solely with the designated product. Do not use it for any other products. Otherwise, it may cause problems in operation and/or trouble.</p>
	<p>Insert the AC plug completely. If the plug is not inserted completely, fire due to overheating or electric shock may result. • Do not use a damaged plug or loose AC outlet.</p>
	<p>Clean dust and other debris of the AC plug regularly. If dust or other debris accumulates on the plug, humidity, etc. may cause a defect in the insulation, which may result in a fire. • Pull the plug, and wipe it with a dry cloth. Pull the plug if the computer is not being used for a long period of time.</p>

	<p>If a malfunction or trouble occurs, immediately stop use.</p> <ul style="list-style-type: none"> • This product is damaged • Water or foreign objects have found their way inside the product • Smoke emitted • Abnormal odors or sounds are being emitted • Unusually hot <p>Continuing to use this product while any of the above conditions are present may result in fire or electric shock. • If a malfunction or trouble occurs, immediately turn the power off and unplug the AC plug. Then contact your technical support office for repair.</p>
	<p>Do not connect the AC adaptor to a power source other than a standard household AC outlet. Otherwise, a fire due to overheating may result. Connecting to a DC/AC converter (inverter) may damage the AC adaptor. On an airplane, only connect the AC adaptor/charger to an AC outlet specifically approved for such use.</p>
	<p>Do not touch this product and cable when it starts thundering. Electric shock may result.</p>
	<p>Do not pull or insert the AC plug if your hands are wet. Electric shock may result.</p>

 CAUTION	
	<p>Hold the plug when unplugging the AC plug. Pulling on the cord may damage the cord, resulting in a fire or electric shock.</p>
	<p>Do not splash water on the AC adaptor or moisten the AC adaptor with water. Doing so may cause the battery to short-circuit or generate heat, possibly resulting in a fire, electric shocks and/or injury.</p> <ul style="list-style-type: none"> • If the unit gets wet, disconnect the AC adaptor and AC plug immediately, and contact your technical support office.
	<p>Use only the AC cord provided with the product; do not use any other AC cord. Using a AC cord which is not the one provided may cause a fire and/or electric shocks.</p>
	<p>Do not use the accessory AC cord provided with this product for any other product. Otherwise, it may cause fire or electric shock.</p>
	<p>Do not disassemble this product. You may receive an electric shock, or foreign matter may enter and result in a fire.</p>
	<p>To ensure safety, disconnect the AC plug from the AC outlet when cleaning the product or when the product is not going to be used for a prolonged period. Otherwise, it may cause fire or electric shock.</p>

	<p>Do not subject the AC adaptor to strong impact. Continuing to use an AC adaptor which has been dropped or otherwise subjected to a strong impact may result in electric shocks, short-circuiting and/or a fire.</p> <ul style="list-style-type: none"> • Contact your technical support office for repair.
---	--

NOTICE

- Do not place the computer near a television or radio receiver.
- Keep the computer away from magnets. Data stored on the flash memory may be lost.
- This computer is not intended for the display of images for use in medical diagnosis.
- This computer is not intended for a use with connection of medical equipment for the purpose of medical diagnosis.
- Panasonic shall not be liable for loss of data or other incidental or consequential damages resulting from the use of this product.
- If this computer will not be used for a long period of time (a month or more), charge or discharge (use) the battery until the remaining battery level becomes 30 % to 40 % and store the product in a cool, dry place.
- This computer prevents overcharging of the battery by recharging only when the remaining power is less than approx. 95 % of capacity.
- The battery is not charged when this computer is first purchased. Be sure to charge it before using it for the first time. When the AC adaptor is connected to this computer, charging begins automatically.
- Should the battery leak and the fluid get into your eyes, do not rub your eyes. Immediately flush your eyes with clear water and see a doctor for medical treatment as soon as possible.

NOTE

- The battery may become warm during recharging or normal use. This is completely normal.
- Recharging will not commence if internal temperature of the battery is outside of the allowable temperature range (0 °C to 50 °C) {32 °F to 122 °F}. Once the allowable range requirement is satisfied, charging begins automatically. Note that the recharging time varies based on the usage conditions. (Recharging takes longer than usual when the temperature is 10 °C {50 °F} or below.)
- If the temperature is low, the operating time is shortened. Only use the computer within the allowable temperature range.
- The battery is a consumable item. If the amount of time the computer can be run by using a particular battery becomes dramatically shorter and repeated recharging does not restore its performance, the battery should be replaced with a new one. Contact your technical support office.
- Always power off the computer when it is not in use. Leaving the computer on when the AC adaptor is not connected will exhaust the remaining battery capacity.

THIS PRODUCT IS NOT INTENDED FOR USE AS, OR AS PART OF, NUCLEAR EQUIPMENT/SYSTEMS, AIR TRAFFIC CONTROL EQUIPMENT/SYSTEMS, AIRCRAFT COCKPIT EQUIPMENT/SYSTEMS *1, MEDICAL DEVICES OR ACCESSORIES *2, LIFESUPPORT SYSTEMS OR OTHER EQUIPMENTS/DEVICES/SYSTEMS THAT ARE INVOLVED WITH ENSURING HUMAN LIFE OR SAFETY. PANASONIC WILL NOT BE RESPONSIBLE FOR ANY LIABILITY RESULTING FROM THE USE OF THIS PRODUCT ARISING OUT OF THE FOREGOING USES.

*1 AIRCRAFT COCKPIT EQUIPMENT/SYSTEMS include Class2 Electrical Flight Bag (EFB) Systems and Class1 EFB Systems when used during critical phases of flight (e.g., during take-off and landing) and/or mounted on to the aircraft. Class1 EFB Systems and 2 EFB Systems are defined by FAA: AC (Advisory Circular) 120-76A or JAA: JAA TGL (Temporary Guidance Leaflets) No.36.

*2 As defined by the European Medical Device Directive (MDD) 93/42/EEC. Panasonic cannot guarantee any specifications, technologies, reliability, safety (e.g. Flammability/Smoke/ Toxicity/Radio Frequency Emission, etc) requirements related to aviation standards and medical equipment standards that differ from the specifications of our COTS (Commercial-Off-The-Shelf) products.

This computer is not intended for use in medical equipment including life-support systems, air traffic control systems, or other equipment, devices or systems that are involved with ensuring human life or safety. Panasonic cannot be held responsible in any way for any damages or loss resulting from the use of this unit in these types of equipment, devices or systems, etc.

This computer has been designed so as to minimize shock to the LCD, the leakage of liquid (e.g., water) on to the buttons, etc., but no warranty is provided against such trouble. Therefore, as a precision instrument, be extremely careful in the handling.

Regulatory information

Information to the user

This product and your health

This product, like other radio devices, emits radio frequency electromagnetic energy. The level of energy emitted by this product however is far much less than the electromagnetic energy emitted by wireless devices like for example mobile phones.

Because this product operates within the guidelines found in radio frequency safety standards and recommendations, we believe this product is safe for use by consumers. These standards and recommendations reflect the consensus of the scientific community and result from deliberations of panels and committees of scientists who continually review and interpret the extensive research literature. In some situations or environments, the use of this product may be restricted by the proprietor of the building or responsible representatives of the organization. These situations may for example include:

- Using this product on board of airplanes, or
- In any other environment where the risk of interference to other devices or services is perceived or identified as harmful.

If you are uncertain of the policy that applies on the use of wireless devices in a specific organization or environment (e.g. airports), you are encouraged to ask for authorization to use this product prior to turning on the product.

Regulatory Information

We are not responsible for any radio or television interference caused by unauthorized modification of this product. The correction of interference caused by such unauthorized modification will be the responsibility of the user. We and its authorized resellers or distributors are not liable for damage or violation of government regulations that may arise from failing to comply with these guidelines.

26-M-1

Lithium battery

Lithium battery!

This computer contains a lithium battery to enable the date, time, and other data to be stored. The battery should only be exchanged by authorized service personnel.

Warning!

A risk of explosion from incorrect installation or misapplication may possibly occur.

15-E-1

Pile au lithium!

Le micro-ordinateur renferme une pile au lithium qui permet de sauvegarder certaines données, notamment la date et l'heure. La pile ne doit être remplacée que par un technicien qualifié.

Danger!

Risque d'explosion en cas de non respect de cette mise en garde!

15-F-1

Information for users on collection and disposal of old equipment and used batteries



These symbols on the products, packaging, and/or accompanying documents mean that used electrical and electronic products and batteries should not be mixed with general household waste.

For proper treatment, recovery and recycling of old products and used batteries, please take them to applicable collection points, in accordance with your national legislation and the Directives 2002/96/EC and 2006/66/EC.

By disposing of these products and batteries correctly, you will help to save valuable resources and prevent any potential negative effects on human health and the environment which could otherwise arise from inappropriate waste handling.

For more information about collection and recycling of old products and batteries, please contact your local municipality, your waste disposal service or the point of sale where you purchased the items.

Penalties may be applicable for incorrect disposal of this waste, in accordance with national legislation.

For business users in the European Union

If you wish to discard electrical and electronic equipment, please contact your dealer or supplier for further information.



[Information on Disposal in other Countries outside the European Union]

These symbols are only valid in the European Union. If you wish to discard this product, please contact your local authorities or dealer and ask for the correct method of disposal.



Note for the battery symbol (bottom two symbol examples):

This symbol might be used in combination with a chemical symbol.

In this case it complies with the requirement set by the Directive for the chemical involved.

53-E-1

Safety precautions

<Only for model with wireless WAN>
 The following safety precautions must be observed during all phases of the operation, usage, service or repair of any Computer incorporating wireless WAN modem. Manufacturers of the cellular terminal are advised to convey the following safety information to users and operating personnel and to incorporate these guidelines into all manuals supplied with the product. Failure to comply with these precautions violates safety standards of design, manufacture and intended use of the product. Panasonic assumes no liability for customer failure to comply with these precautions.

Regulatory information



When in a hospital or other health care facility, observe the restrictions on the use of mobiles. Switch Computer incorporating wireless WAN modem off, if instructed to do so by the guidelines posted in sensitive areas. Medical equipment may be sensitive to RF energy. The operation of cardiac pacemakers, other implanted medical equipment and hearing aids can be affected by interference from Computer incorporating wireless WAN modem placed close to the device. If in doubt about potential danger, contact the physician or the manufacturer of the device to verify that the equipment is properly shielded. Pacemaker patients are advised to keep their Computer incorporating wireless WAN modem away from the pacemaker, while it is on.



Switch off Computer incorporating wireless WAN modem before boarding an aircraft. Make sure it cannot be switched on inadvertently. The operation of wireless appliances in an aircraft is forbidden to prevent interference with communications systems. Failure to observe these instructions may lead to the suspension or denial of cellular services to the offender, legal action, or both. For details on usage of this unit in aircrafts please consult and follow instruction provided by the airline.



Do not operate Personal Computer or Handheld Computer incorporating wireless WAN modem in the presence of flammable gases or fumes. Switch off the cellular terminal when you are near petrol stations, fuel depots, chemical plants or where blasting operations are in progress. Operation of any electrical equipment in potentially explosive atmospheres can constitute a safety hazard.



Your Computer incorporating wireless WAN modem receives and transmits radio frequency energy while switched on. Remember that interference can occur if it is used close to TV sets, radios, computers or inadequately shielded equipment. Follow any special regulations and always switch off Computer incorporating wireless WAN modem wherever forbidden, or when you suspect that it may cause interference or danger.



Road safety comes first! Do not use a Computer incorporating wireless WAN modem while driving a vehicle. Do not place the computer with wireless WAN modem in an area where it could cause personal injury to the driver or passengers. It is recommended to stow the unit in the boot or secure storage area while driving. Do not place the computer with wireless WAN modem in an area over an air bag or in the vicinity where an air bag may deploy. Air bags inflate with great force and if the computer with wireless WAN modem is placed in the air bag deployment area may be propelled with great force and cause serious injury to occupants of the vehicle.

SOS

IMPORTANT!

Computer incorporating wireless WAN modem operate using radio signals and cellular networks cannot be guaranteed to connect in all conditions.

Therefore, you should never rely solely upon any wireless device for essential communications, for example emergency calls. Remember, in order to make or receive calls, Computer incorporating wireless WAN modem must be switched on and in a coverage area with adequate cellular signal strength. Some networks do not allow for emergency calls if certain network services or phone features are in use (e.g. lock functions, fixed dialing etc.). You may need to deactivate those features before you can make an emergency call. Some networks require that a valid microSIM card be properly inserted in Computer incorporating wireless WAN modem.

Camera light

CAUTION

Camera light for rear camera

- The light from the LED is strong and can injure human eyes. Do not look directly at the LEDs with naked eyes.

57-E-1

For U.S.A.

<Models for U.S.A.>

Federal Communications Commission Radio Frequency Interference Statement

Note: This equipment has been tested and found to comply with the limits for a Class B digital device, pursuant to Part 15 of the FCC Rules.

These limits are designed to provide reasonable protection against harmful interference in a residential installation. This equipment generates, uses and can radiate radio frequency energy and, if not installed and used in accordance with the instructions, may cause harmful interference to radio communications. However, there is no guarantee that interference will not occur in a particular installation. If this equipment does cause harmful interference to radio or television reception, which can be determined by turning the equipment off and on, the user is encouraged to try to correct the interference by one or more of the following measures:

- Reorient or relocate the receiving antenna.
- Increase the separation between the equipment and receiver.
- Connect the equipment into an outlet on a circuit different from that to which the receiver is connected.
- Consult the Panasonic Service Center or an experienced radio/TV technician for help.

Warning

To assure continued compliance, use only shielded interface cables when connecting to a computer or peripheral. Also, any changes or modifications not expressly approved by the party responsible for compliance could void the user's authority to operate this equipment.

This device complies with Part 15 of the FCC Rules.

Operation is subject to the following two conditions:

- (1) This device may not cause harmful interference, and
- (2) This device must accept any interference received, including interference that may cause undesired operation.

FCC RF Exposure Warning:

- This device meets the government's requirements for exposure to radio waves.
This device is designed and manufactured not to exceed the emission limits for exposure to radio frequency (RF) energy set by the Federal Communications Commission of the U.S. Government.
- This equipment has been approved for portable operation, and does not require any minimum spacing be provided between antennas and all person's body. This equipment may not be colocated or operated with any other antenna or transmitter.
- The exposure standard for wireless device employs a unit of measurement known as the Specific Absorption Rate, or SAR. The SAR limit set by the FCC is 1.6 W/kg.
 - * Tests for SAR are conducted using standard operating positions accepted by the FCC with the device transmitting at its highest certified power level in all tested frequency bands. Although the SAR is determined at the highest certified power level, the actual SAR level of the device while operating can be well below the maximum value. This is because the device is designed to operate at multiple power levels so as to use only the power required to reach the network. In general, the closer you are to a wireless base station antenna, the lower the power output.

- The FCC has granted an Equipment Authorization for this device with all reported SAR levels evaluated as in compliance with the FCC RF exposure guidelines. The maximum SAR value is outlined below:

Model	Highest Value (W/kg)
JT-B1APAAZAM	0.774
JT-B1APAAAAM	1.313
JT-B1APAAVAM	1.230

SAR information on this device is on file with the FCC and can be found under the Display Grant section of www.fcc.gov/oet/ea/fccid after searching on FCC ID: ACJ-JT-B1APAAZAMW, ACJ-JT-B1APAAZAMA, ACJ-JT-B1APAAZAMV.

25-M-4

This product is restricted to indoor use due to its operation in the 5.15 to 5.25 GHz frequency range. FCC requires this product to be used indoors for the frequency range 5.15 to 5.25 GHz to reduce the potential for harmful interference to co-channel Mobile Satellite systems. High power radars are allocated as primary users of the 5.25 to 5.35 GHz and 5.65 to 5.85 GHz bands. These radar stations can cause interference with and /or damage this product.

25-M-W-4

Responsible Party: Panasonic Corporation of North America
 One Panasonic Way
 Secaucus, NJ 07094
 Tel No: 1-800-LAPTOP5 (1-800-527-8675)

6-M-1

USA Only: Disposal may be regulated in your community due to environmental considerations.

For disposal or recycling information, please visit Panasonic website: <http://www.panasonic.com/environmental> or call 1-888-769-0149

65-M-2

CAUTION:

Risk of Explosion if Battery is replaced by an Incorrect Type.
 Dispose of Used Batteries According to the Instructions.

58-E-1

ATTENTION:

Il y a risque d'explosion si la batterie est remplacée par une batterie de type incorrect.

Mettre au rebut les batteries usagées conformément aux instructions.

58-F-1



A lithium ion battery that is recyclable powers the product you have purchased. Please call 1-800-8-BATTERY for information on how to recycle this battery.

L'appareil que vous vous êtes procuré est alimenté par une batterie au lithium-ion. Pour des renseignements sur le recyclage de la batterie, veuillez composer le 1-800-8-BATTERY.

48-M-1

For Canada

<Models for Canada>

Canadian ICES-003

This Class B digital apparatus complies with Canadian ICES-003.

Cet appareil numérique de la classe B est conforme à la norme NMB-003 du Canada.

7-M-2

<Only for model with Wi-Fi/Bluetooth/GPS>

Industry Canada

This product complies with RSS210 Industry Canada. Operation is subject to the following two conditions;

- (1) this device may not cause interference, and

Regulatory information

- (2) this device must accept any interference, including interference that may cause undesired operation of the device.

30-Ca-1-1

Industrie Canada

Cet équipement est conforme à la norme CNR-210 d'Industrie Canada. Son fonctionnement est soumis aux deux conditions suivantes :

- (1) ce dispositif ne peut produire de brouillage, et
(2) ce dispositif doit accepter le brouillage, y compris le brouillage pouvant entraîner le fonctionnement non désiré de l'appareil.

30-Ca-1

This product (local network devices) for the band 5150-5250 MHz is only indoor usage to reduce potential for harmful interference to co-channel Mobile Satellite systems.

High power radars are allocated as primary users (meaning they have priority) of 5250-5350 MHz and 5650-5850 MHz and these radars could cause interference and/or damage to LELAN devices.

Cet appareil (pour réseaux locaux radioélectriques) dans les bandes de fréquences 5150-5250 MHz est réservé à une utilisation à l'intérieur afin de réduire le risque d'interférence avec les systèmes satellites mobiles bicanaux.

Les radars forte puissance sont désignés comme étant les premiers utilisateurs (c'est-à-dire qu'ils ont la priorité) des bandes de fréquences 5250-5350 MHz et 5650-5850 MHz. Ces stations radars peuvent provoquer des interférences et/ou des dommages à ce périphérique.

30-Ca-2-1

- This computer complies with Industry Canada radiation exposure limits set forth for an uncontrolled environment.
- This computer with WLAN and/or Bluetooth transmitters installed, has been approved for portable operation and does not require any minimum spacing be provided between antennas and all person's body.

- Cet équipement est conforme aux limites d'exposition aux rayonnements d'Industrie Canada établies pour un environnement non contrôlé.
- Ce équipement avec émetteurs WLAN et/ou Bluetooth a été approuvé à des fins d'opération mobile; aucun espace minimum entre les antennes et le corps de l'utilisateur n'est requis.

25-Ca-1

FOR USE WITH MODEL NO. :
JT-B1-AD000U
POUR UTILISER AVEC MODÈLE :
JT-B1-AD000U
20-Ca-1

For Europe

<Only for model with a “  ” mark on the bottom of the computer>



Declaration of Conformity (DoC)
“Hereby, Panasonic declares that this

Personal Computer is in compliance with the essential requirements and other relevant provisions of the Directive 1999/5/EC.”

Hint:

If you want to get a copy of the original DoC of our above mentioned products, please contact our web address:
<http://www.doc.panasonic.de>

Authorised Representative:
Panasonic Testing Centre
Panasonic Marketing Europe GmbH
Winsbergring 15, 22525 Hamburg,
Germany

Indication of the countries where WLAN is intended to be used:

AT BE BG CH CY CZ DE DK EE ES
FI FR GB GR HU IE IS IT LT LU
LV MT NL NO PL PT RO SE SI SK TR

18-25-E-0

Interface Cable

Use of an interface cable longer than 3 m { 9.84 feet } is not recommended.

11-E-1



For UK

<Models for UK>

For your safety, please read the following text carefully.

This appliance is supplied with a molded three pin mains plug for your safety and convenience.

A 3 ampere fuse is fitted in this plug. Should the fuse need to be replaced please ensure that the replacement fuse has a rating of 3 ampere and that it is approved by ASTA or BSI to BS1362.

Check for the ASTA mark  or the BSI mark  on the body of the fuse.

If the plug contains a removable fuse cover you must ensure that it is refitted when the fuse is replaced.

If you lose the fuse cover the plug must not be used until a replacement cover is obtained. A replacement fuse cover can be purchased from your local dealer.

If the fitted molded plug is unsuitable for the socket outlet in your home then the fuse should be removed and the plug cut off and disposed of safely.

There is a danger of severe electrical shock if the cut off plug is inserted into any 13-ampere socket.

How to replace the fuse

The location of the fuse differs according to the type of AC mains plug (figures A and B). Confirm the AC mains plug fitted and follow the instructions below. Illustrations may differ from actual AC mains plug.

Open the fuse cover with a screwdriver and replace the fuse and close or attach the fuse cover.

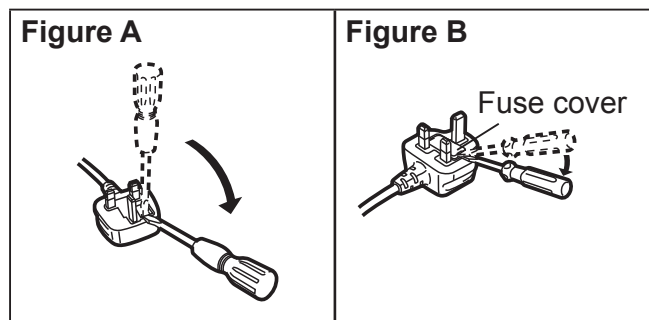
**For India**

For the purpose of recycling to facilitate effective utilization of resources, please return this product to a nearby authorized collection center, registered dismantler or recycler, or Panasonic service center when disposing of this product. Please see the Panasonic website for further information on collection centers, etc. <http://www.panasonic.co.in/wps/portal/home>

Handling and maintenance

Operation environment

- Place this computer on a flat stable surface. If this computer is exposed to an extremely strong impact, it may become damaged.
- Temperature:
 - Operation: -10 °C to 50 °C {14 °F to 122 °F} (IEC60068-2-1, 2)*1
 - Storage: -20 °C to 60 °C {-4 °F to 140 °F}
- Humidity:
 - Operation: 20 % to 80 % RH (No condensation)
 - Storage: 5 % to 90 % RH (No condensation)

Even within the above temperature/humidity ranges, using for a long time in an extreme environment will result in the product deterioration and will shorten the product life. If this computer is wet in temperatures of 0 °C {32 °F} or below, freeze damage may occur. Make sure to dry off this computer in such temperatures.

*1 Do not expose the skin to this product when using the product in a hot or cold environment.

- Do not place this computer in the following areas, otherwise the computer may be damaged.
 - Near electronic equipment. Image distortion or noise may occur.
 - In extremely high or low temperature.
- As this computer can become hot during operation, keep it away from items that are sensitive to heat.

Handling cautions

This computer has been designed in such a way as to minimize impact on its LCD screen and internal electronic components, but this does not constitute a guarantee that this computer will be free of trouble in the event that it has been subjected to impact. Be extremely careful when handling this computer.

- When carrying this computer:
 - Either turn off this computer's power or set the computer to the sleep mode.

- Remove all external devices, cables and other protruding objects.
- Do not drop or hit this computer against solid objects.
- Do not grip the display part.
- Before boarding an airplane, turn off this computer's power and take it on board as a carry-on item. When using this computer on airplane, follow the airline's instructions.
- Use only your fingers or the stylus pen to touch the LCD screen. Do not place any object on its surface and do not press down strongly with sharp-pointed or hard objects that may leave marks (e.g., nails, pencils and ball point pens).
- Do not use the screen when dust or dirt (e.g., oil) is on the screen. Otherwise foreign particles on the screen can scratch the screen surface.

When using peripheral devices

Follow these instructions and the Reference Manual to avoid any damage to the devices. Carefully read the instruction manuals of the peripheral devices.

- Use the peripheral devices conforming to this computer's specifications.
- Connect to the connectors in the correct direction.
- If it is hard to insert, do not try forcibly but check this computer's shape, direction, alignment of pins, etc.

Preventing this computer from unauthorized use via wireless networks

- Before using Wi-Fi/Bluetooth/wireless WAN*2, make the appropriate security settings such as data encryption.
- *2 Only for model with wireless WAN.

Maintenance

To clean the LCD panel

- When the screen becomes dirty, wipe it with an approved soft cloth.
The screen is specially treated to prevent dirt from adhering to the surface, so dirt can be removed easily using a dry cloth (use only the approved soft cloth).
Remove the dirt, water, etc. as soon as possible. Otherwise, the LCD panel is stained or changes in quality.
If the dirt does not come off easily, breathe on the surface and try again.
- Suggestions About Cleaning the LCD Surface
To improve the outdoor visibility of the display, a low reflection coating has been added. In order to avoid scratches and peeling of this coating, an approved soft cloth has been included to wipe the LCD surface of this computer. Before using this computer, be sure to read the instructions provided below.

- Be sure to wipe the LCD display to remove fingerprints, etc., with the soft cloth.
- Do not wipe areas other than the LCD display with the soft cloth.

How to use the soft cloth

- Use the soft cloth when it is dry. Do not apply water or solvents to the soft cloth.
- When the LCD display gets wet, wipe it gently with an approved soft cloth.
- It is recommended to wipe the LCD display before using this computer.
- First, lightly wipe foreign particles and dust adhering to the LCD display on one side of the soft cloth. Do not use force, since the LCD surface may be damaged with the foreign particles or dust.
Next, wipe off fingerprint, etc., with the other side of the soft cloth.
After wiping off foreign particles and dust, wash the soft cloth (refer to the following) to remove the foreign particles and dust from the soft cloth.

- Clean the screen while the computer is powered off.
Cleaning the screen while the power is on may cause the computer to malfunction. Also, dirt on the screen is easier to see when the computer is powered off, and so is easier to clean.
- Wash the soft cloth when it becomes dirty.
When the soft cloth becomes dirty, wash it with mild detergent. Do not use bleach or fabric conditioner (softener), or try to sterilize the cloth by boiling.
If the soft cloth is dirty, it may be ineffective in cleaning the screen, and in fact may cause dirt to adhere to the screen.
- Check the following to prevent the surface of the screen from being scratched.
 - Are you using your finger or a stylus pen to operate the screen?
 - Is the surface clean?
 - Is the soft cloth clean?
 - Is your finger or the stylus pen clean?

To clean areas other than the LCD panel

Wipe with a soft dry cloth such as gauze.
When using detergent, dip a soft cloth in some detergent which has been diluted with water, wring out the cloth thoroughly, and clean the product with the battery pack still installed. After cleaning, wipe down the surfaces of the product with a dry cloth.

CAUTION

- Do not use benzene, thinner, or rubbing alcohol since it may adversely affect the surface causing discoloration, etc. Do not use commercially-available household cleaners and cosmetics, as they may contain components harmful to the surface.
- Do not apply water or detergent directly to the computer, since liquid may enter inside of the computer and cause malfunction or damage.

Dispose of computer



- Remove the microSD memory card and other peripherals.
- Perform “Factory data reset” to erase the stored data. (→ page 40)

Battery pack

- The battery pack is a consumable. The battery life, which varies with using conditions, is approximately a year as a guideline, and after a year or approximately over 300 times of recharging, the recharging capability becomes weak. If the battery is exhausted in a short time after full recharging, replace the battery pack with new one.
- Be sure to use the specified battery pack.
- Do not touch the contact portions of the battery pack. Failure to observe this may cause poor contact.
- Leaving this product for a long time after recharging reduces the battery capacity even if the power is turned off.
- Recharge the battery pack at ambient temperatures from 10 °C to 35 °C {50 °F to 95 °F}.
- Store the battery pack at ambient temperatures from -20 °C to 20 °C {-4 °F to 68 °F}. Storing the battery pack outside of the specified temperatures reduces the performance and life of the battery pack.
- Charge the battery pack before use.
- When the terminal of the battery pack becomes dirty, use a dry soft cloth to clean the terminal. Failure to observe this may cause poor contact with the device and cut power supply.
- Once the terminal of the battery pack is clogged with foreign matter, the matter is hard to be removed, resulting in damage to the device.
- If an anomaly such as heat generation, deformation, and abnormal odor is detected with respect to the battery pack, do not use the battery pack.
- If recharging is not completed after the specified recharging time has passed, remove the battery pack from the device. The battery pack protection device may be damaged.
- The battery pack is a lithium-ion battery.
- Do not dispose of but recycle no longer needed batteries to protect precious resources.

Introduction

Terms and illustrations in these instructions

	Page in these Operating Instructions or in the Reference Manual.
	Reference to the on-screen manuals.

- Some illustrations are simplified to help your understanding and may look different from the actual unit.
- Refer for the latest information about optional products to the catalogs, etc.

Disclaimer

Computer specifications and manuals are subject to change without notice. Panasonic Corporation assumes no liability for damage incurred directly or indirectly from errors, omissions or discrepancies between the computer and the manuals.

Trademarks / Licenses

- Google, the Google logo, Google Search, Gmail, Android and Google Play are trademarks of Google, Inc.
- OMAP4460 is a registered trademark of Texas Instruments Incorporated.
- microSDHC Logo is a trademark of SD-3C, LLC.
- Adobe, the Adobe logo and Adobe Reader are either registered trademarks or trademarks of Adobe Systems Incorporated in the United States and/or other countries.

- Bluetooth® is a registered trademark owned by Bluetooth SIG, Inc., U.S.A. and licensed to Panasonic Corporation.
- Wi-Fi, the Wi-Fi logo, the Wi-Fi CERTIFIED logo and Wi-Fi CERTIFIED are trademarks or registered trademarks of Wi-Fi Alliance.
- The N-Mark logo is a trademark or registered trademark of NFC Forum.
- Names of products, brands, etc., appearing in this manual are trademarks or registered trademarks of their respective own companies.

This product is licensed under the AVC Patent Portfolio License and MPEG-4 Visual Patent Portfolio License for the personal use of a consumer or other uses in which it does not receive remuneration to (i) encode video in compliance with the AVC Standard and MPEG-4 Visual Standard (“AVC/MPEG-4 Video”) and/or (ii) decode AVC/MPEG-4 Video that was encoded by a consumer engaged in a personal activity and/or was obtained from a video provider licensed to provide AVC/MPEG-4 Video. No license is granted or shall be implied for any other use. Additional information may be obtained from MPEG LA, LLC. See <http://www.mpegla.com>.

Confirmation of accessories

Before using, check the following accessories.

If you do not find the described accessories, contact your technical support office.

■ Main unit

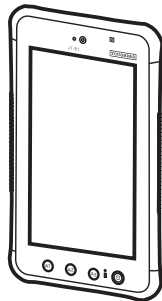

■ AC adaptor

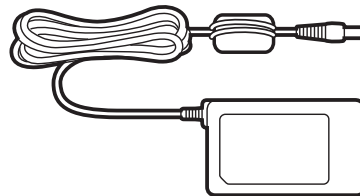

■ AC cord (Shape depends on the country.)

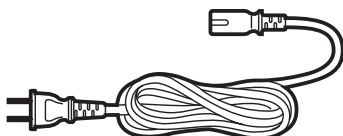

■ Battery pack



■ OPERATING INSTRUCTIONS (this document)

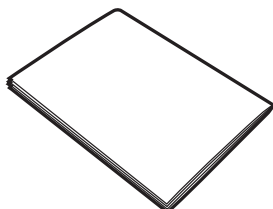

■ Soft cloth



■ Hand strap

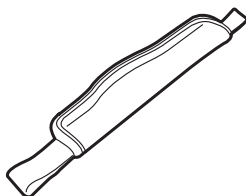

Description of parts

Front side

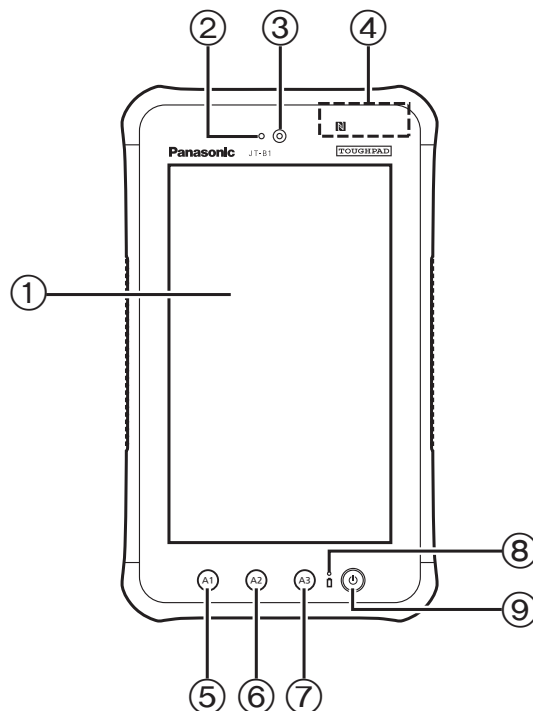

No.	Name	Description
①	LCD	The LCD screen operations are performed using a touch panel system.
②	Ambient light sensor	This is used when the LCD brightness is adjusted automatically. <ul style="list-style-type: none"> Do not block or cover the sensor area.
③	Front camera	This is used when taking photos and videos.
④	Contactless IC card reader/writer	This reads data from contactless IC cards and writes data onto the cards.
⑤	Application button [A1]	This is used to execute the function assigned to the button by the software application. In the initial status, "BACK" is the function assigned.
⑥	Application button [A2]	This is used to execute the function assigned to the button by the software application. In the initial status, "HOME" is the function assigned.
⑦	Application button [A3]	This is used to execute the function assigned to the button by the software application. In the initial status, "MENU" is the function assigned.
⑧	Battery indicator	This lights up when the battery pack is being charged (→ page 30). It lights red as soon as the remaining charge of the battery pack has dropped less than 15 % of a full charge during use.
⑨	Power button	This is used to turn the power on and off and establish the sleep mode or wake-up mode.

Description of parts

Rear side

Rear side

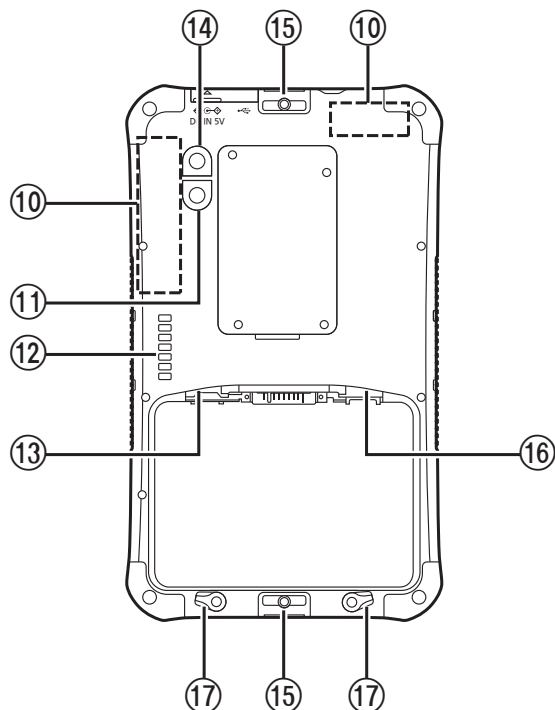

When the hand strap has been attached and the battery pack installed

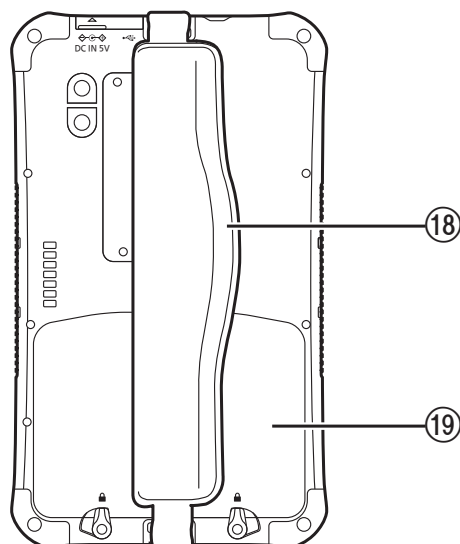

No.	Name	Description
⑩	Wireless WAN* ¹ /Wireless LAN/GPS Antenna	These are used for wireless communication.
⑪	Camera light	This is used for flashing when taking photos and videos.
⑫	Expansion Bus Connector	This is used for making the connection with the optional cradle* ² and for expansion to accommodate future functions.
⑬	microSD memory card slot	Slot for microSD/microSDHC
⑭	Rear camera	This is used when taking photos and videos.
⑮	Area where the hand strap is attached	Pass one end of the hand strap through this hole to attach the strap.
⑯	microSIM card slot* ¹	This is where the microSIM card is inserted.
⑰	Battery pack lock	This is used when installing and removing the battery pack.
⑱	Hand strap	Loop the strap over your hand for use.
⑲	Battery pack	This supplies power to the unit. It can be exchanged for another battery pack.

*¹ Only for model with wireless WAN

*² Not available in some countries.

Side panels

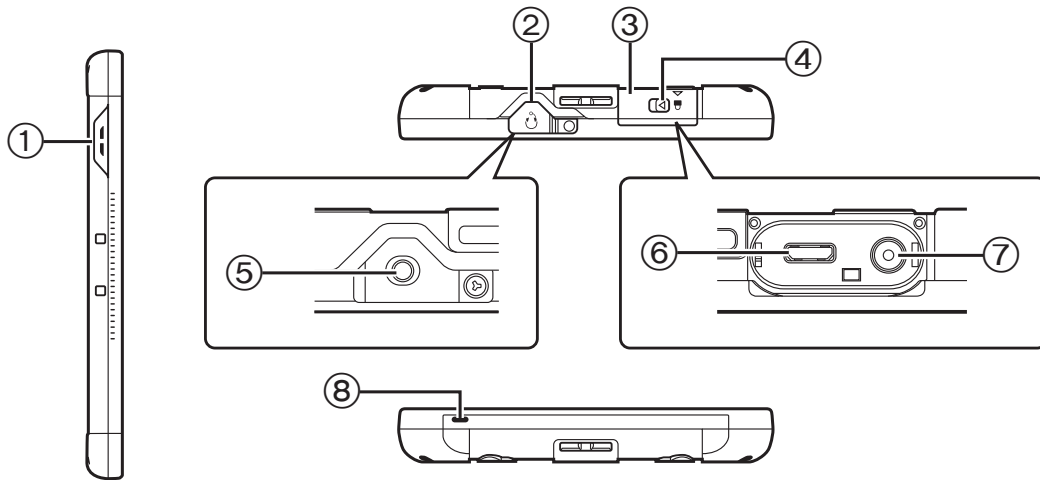

No.	Name	Description
①	Speaker	This emits the sounds accompanying the operations and other tones.
②	Audio output jack cover	This protects the audio output jack.
③	Interface cover	This protects the DC-IN jack and USB 2.0 Micro-B connector.
④	Interface cover lock	This locks the interface cover.
⑤	Audio output jack	This is where the headset or earphones are connected.
⑥	USB 2.0 Micro-B connector	This is connected to the USB device.
⑦	DC-IN jack	This is where the plug of the dedicated AC adaptor is connected.
⑧	Microphone	This is used for voice input.

Description of parts

How to open and close the interface cover

Slide the lever with the ◁ mark in the direction shown by the arrow.

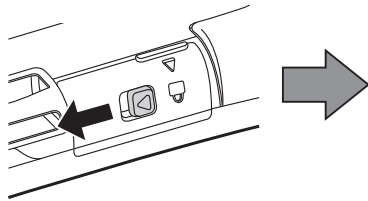

Pull the lever in the direction shown by the arrow, and open the cover.

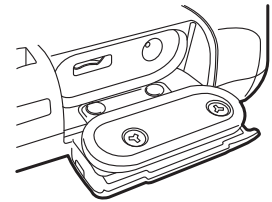
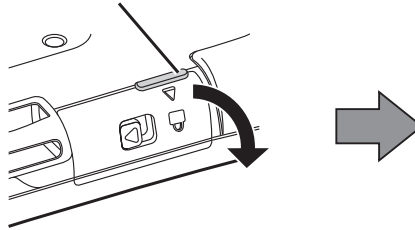

Close the cover firmly.

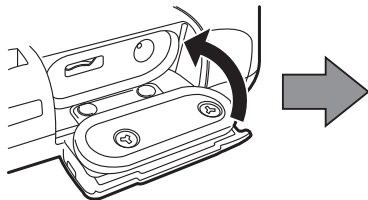

Slide the lever with the ◁ mark in the direction shown by the arrow, and lock the cover.

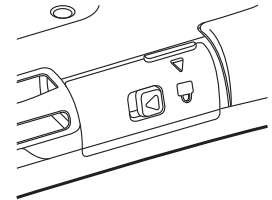
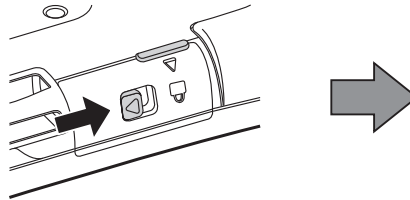

How to open and close the audio output jack cover

Use your fingernail here to open the cover, and pull out the cover in the direction shown by the arrow.

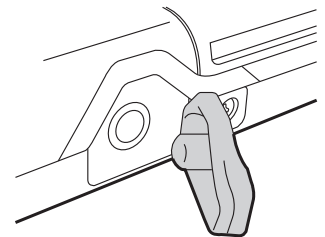
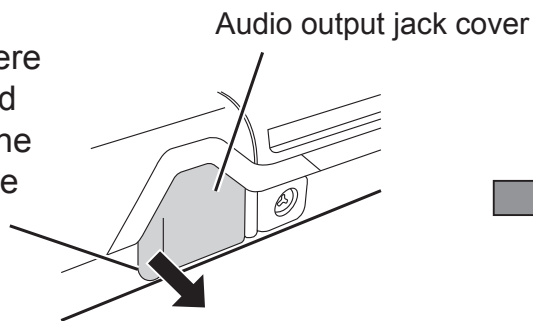



- In order to ensure the dust-tight and water-proof performance of the product, use the product with the cover installed securely in place when the DC-IN jack, USB 2.0 Micro-B connector and audio output jack are not being used.

Input operation

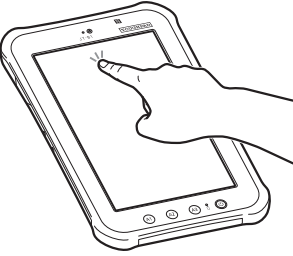
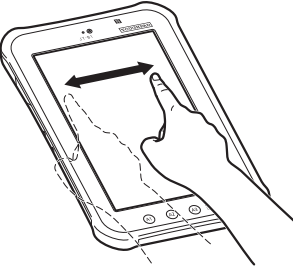
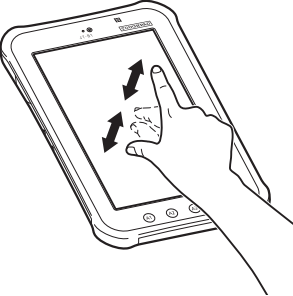
Screen input operation

Touch 	Select items or options.
Touch and hold	Open special options.
Drag	Scroll the screen.
Flick 	Scroll the screen quickly.
Drag and drop	Move an item.
Pinch 	Zoom in or out the screen. Depending on the applications, you can also zoom in or out by double-touching the screen.

Buttons

A1	Return to the previous screen. The same function as [].
A2	Return to the home screen. The same function as [].
A3	Open the menu.

- The functions of the buttons can be changed using the application.
(→  Reference Manual “Input Operation – Application buttons”)

Turning on/off and sleeping/waking up

Turning on

- 1 Hold down  (power button) until the unit vibrates for a moment.

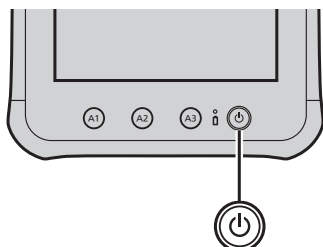

- If the battery indicator blinks three times in red five seconds after the power button has been held down and the product has vibrated for a moment, it means that the remaining charge of the battery pack is less than 1 % of a full charge, and the product will not start up.

Turning off

- 1 Exit the operation of all the functions, and hold down  (power button) until “Shut down?” is displayed.
- 2 Touch “OK”.

Sleeping

- 1 With the power ON, press  (power button).
- The screen goes off, and the product is placed in the sleep mode.
 - When the product enters the sleep mode, no further operations are possible.
- In order to conserve the battery power, the product is placed in the sleep mode when it has not been used for the prescribed period of time. If this happens while the characters or whatever else is being input, they may be cleared.

Waking up

- 1 Press  (power button).
- The screen comes on, and operations can now be performed.

First-time operation

Preparation

1 Installing the battery pack

1. Release the battery pack locks.

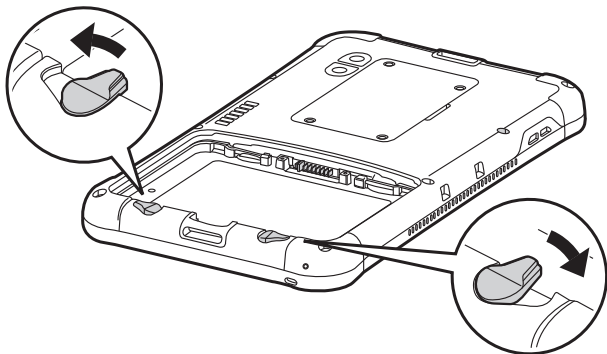

2. Install the battery pack.

- ① Precisely align the tabs of the battery pack, and press the battery pack up against the wall.
- ② Keep pushing the battery pack into place firmly until it moves no further.

Align the tabs.

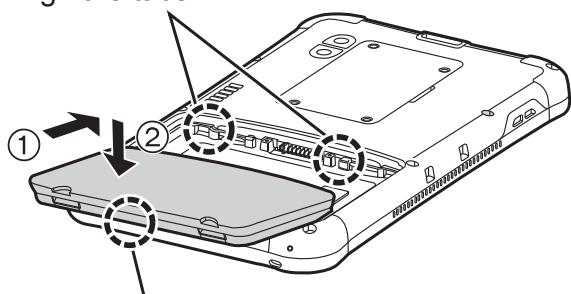

Push the bottom side of the battery pack down into position.

3. Engage the battery pack locks.

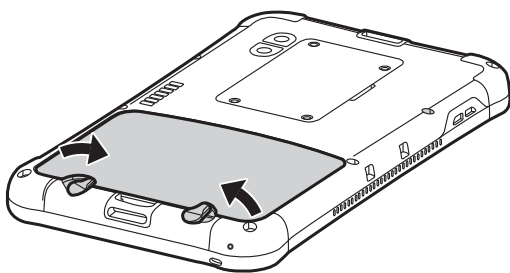

- Turn the battery pack locks until you hear a clicking sound to lock the battery pack in place.

2 Charging this computer using the AC adaptor

Described below are the steps to take to charge the battery pack in this computer.

1. Connect one end of the AC cord to the AC adaptor.

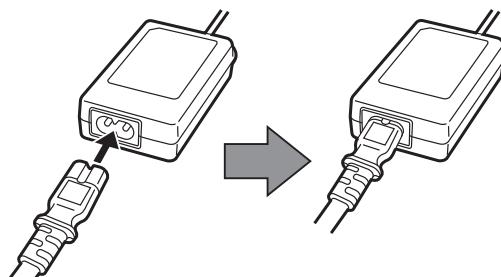

2. Open this computer's interface cover.

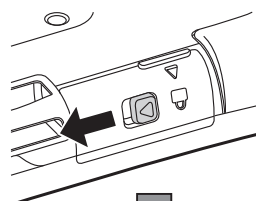

Slide the lever with the ◀ mark in the direction shown by the arrow.

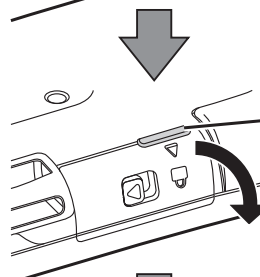

Pull the lever in the direction shown by the arrow, and open the cover.

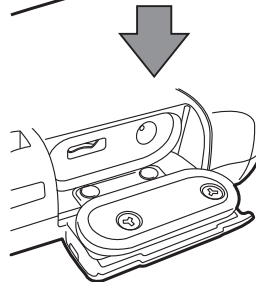

3. Insert the AC adaptor's plug firmly into the DC-IN jack.

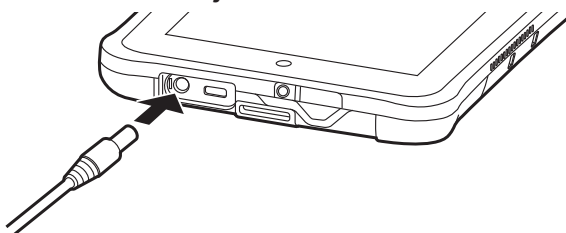

First-time operation

4. Connect the other end of the AC cord to the AC outlet.
5. The battery indicator lights up as soon as charging starts.



The battery indicator lights up.

Battery indicator during charging

Lights up in green	Full charge
Lights up in orange	Charge is less than 99 % of a full charge; charging still underway.
Blinks in orange	Abnormal temperature
Off	No charging/discharging

- If charging is started in a state where the remaining battery charge is close to 0 %, the battery indicator may not light up immediately.

Starting Up

- 1 Hold down  (power button) until the unit vibrates for a moment.

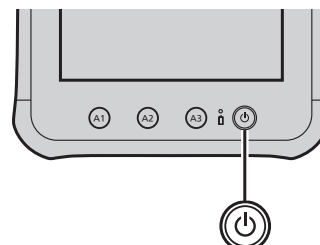

- If the battery indicator blinks three times in red five seconds after the power button has been held down and the product has vibrated for a moment, it means that the remaining charge of the battery pack is less than 1 % of a full charge, and the product will not start up.

CAUTION

- Do not disconnect the AC adaptor until the first-time operation procedure is completed.
- When using this computer for the first time, do not connect any peripheral device except the AC adaptor.
- Handling the AC adaptor
 - Problems such as sudden voltage drops may arise during periods of thunder and lightning. Since this could adversely affect this computer, an uninterruptible power source (UPS) is highly recommended unless running from the battery alone.

- 2** If necessary, touch the language name and scroll the language list, then touch the language you use.

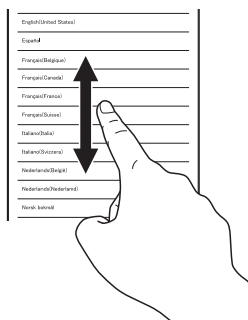

- 3** Touch [Start].

<Only for model with wireless WAN>
If “SIM card not found” is displayed, touch [Skip]. Then touch [Skip] or configure wi-fi settings by following the on-screen instructions.

- 4** Touch and scroll the time zone list and touch the time zone for your location.

- If necessary, set date and time or set [Automatic date & time] to [ON].

- 5** Touch [Next].

- “Sign in with your Google Account” screen is displayed.

- 6** If necessary, set up your Google account by following the on-screen instructions.

- If you set up your Google account, you can use Gmail, Calendar, etc.

- 7** When “Use Google location” is displayed, check what is displayed on the screen, and touch [Next].
(To remove the check mark, touch the applicable check box.)

- 8** When “This tablet belongs to...” is displayed, input your name and touch [Next].

- 9** Read “Google services” and touch [Next].

- 10** When “Setup complete” is displayed, touch [Finish].

- 11** When “Make yourself at home” is displayed, touch [OK].

First-time operation

Home screen

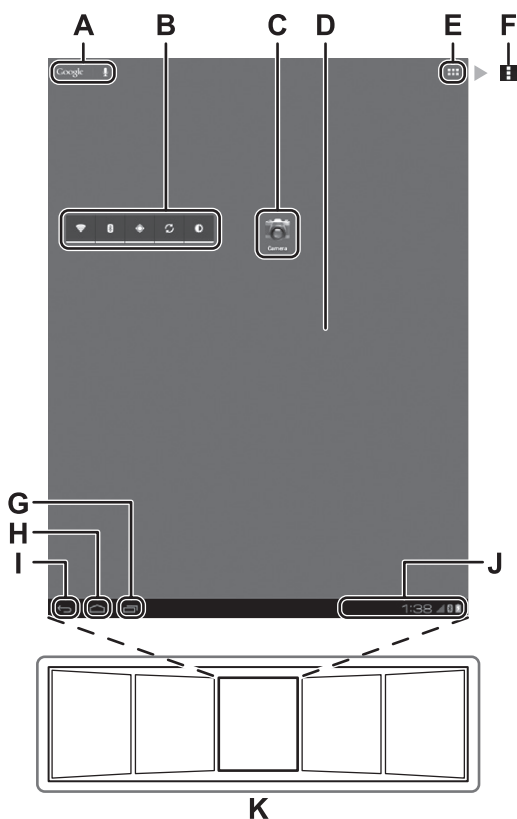

* The screen configuration may differ depending on the software version used.

A Google Search/Voice search
Search the internet and this computer using Google search. You can input the search terms by using on-screen keyboard or speaking.

B Widgets
The small applications on the home screen. Some widgets display the latest information (clock, calendar, weather, email, etc.) on the home screen.

C Application shortcuts
Open an application. You can add/remove applications shortcuts to/from the home screen.

D Home screen
The starting point for this computer. You can place shortcuts, widgets and other items to the home screen.

E Apps
Display all applications and widgets. Touch an application/widget to open from the list.

F Menu
Depending on the applications,  is displayed at the top-right of the screen. You can select additional functions from the menu.

G Recent apps
Display the recent applications. Touch an application to open from the application list. To stop the application, drag it to the right.

H Home
Return to the home screen.

I Back
Return to the previous screen.

J Status detail and quick settings
Touch this area to open the status detail (notification icons, status icons and clock) (→  Reference Manual “Home Screen – Notification Icons”, “Home Screen – Status Icons”). Touch the status detail to open the quick settings. The quick settings display network status, remaining battery charge and other details.

When you touch [ Settings], Settings application is opened.

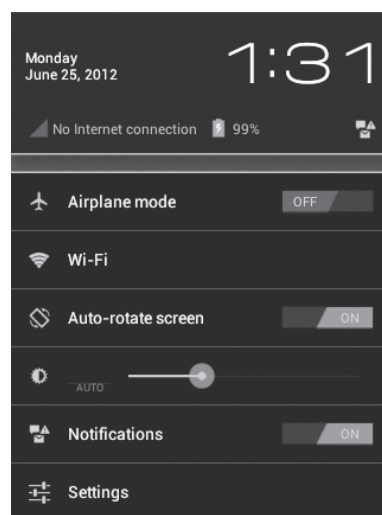

K Panels
This computer has 5 panels. Flick left or right to display the next panel.

How to attach the hand strap

The steps taken to attach the hand strap to the product are described below.

- 1** Take note of which end of the hand strap is which, and pass the strap through the strap holes at the top and bottom.

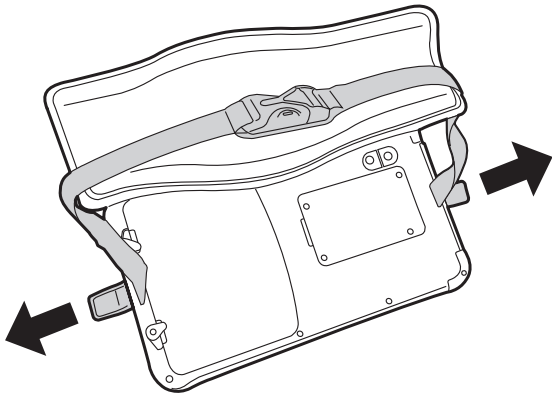

- 2** Pass one end of the strap all the way through, fold it back as shown in the figure and hold it in place with your hand, and adhere the hook-and-loop fastener.

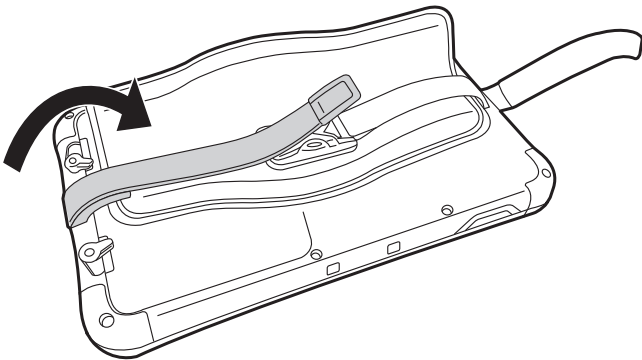

- 3** Fold back the other end of the strap so that it fits the size of your hand, hold it in place with your hand, and adhere the hook-and-loop fastener.

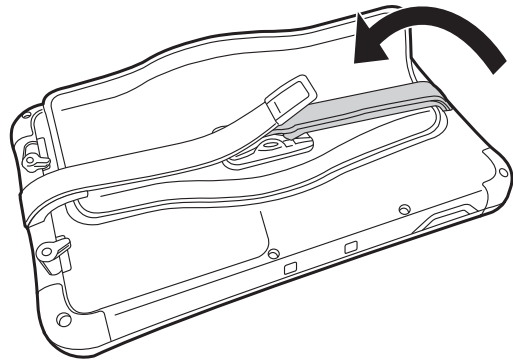

- 4** Place the pads on top: This completes the process.

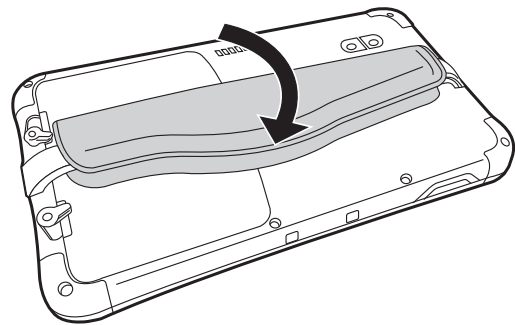

How to change the battery pack

Described below are the steps to take to change the battery pack. Before changing the battery pack, place the unit on a desk or table.

1 Turn off this computer's power.

- For the procedure to turn off the power, refer to "Turning off" on page 28.

2 <This step applies only when the hand strap is attached.>

With this computer placed on a desk or table, open out the pad of the hand strap.

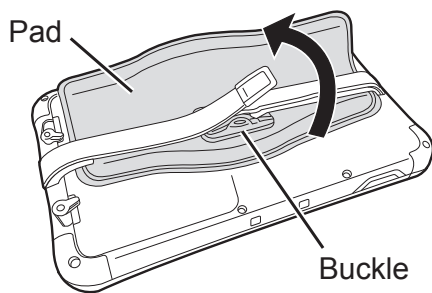

3 <This step applies only when the hand strap is attached.>

Remove the buckle, and extend the ends of the strap.

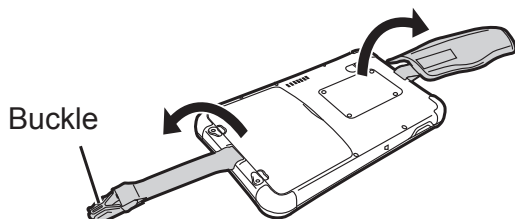

4 Release the battery pack locks.

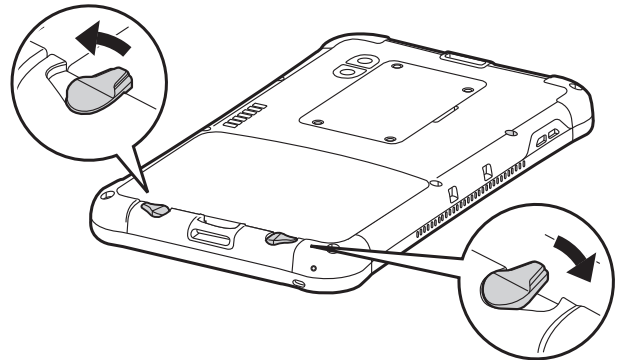

5 Remove the battery pack.

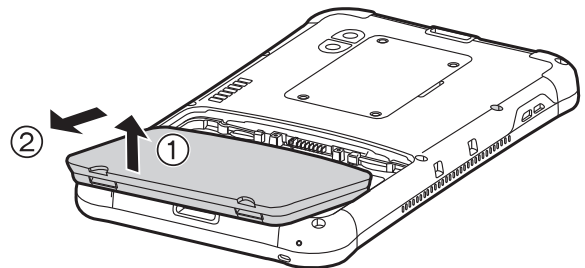

- Take the steps for removing the battery pack with this computer on a desk, table or other such surface.
- Ensure that the battery pack will not fall.

- If it proves difficult to remove the battery pack, hook the buckle of the strap over the grip, and turn it in the direction shown by the arrow to remove the battery pack.

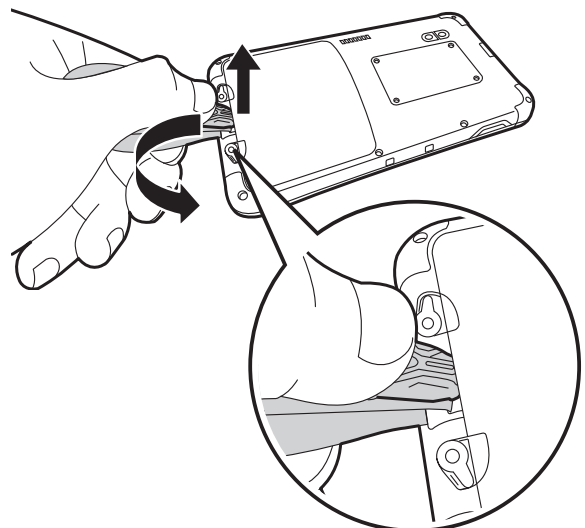

- Due to the design adopted to ensure the dust-tight and water-proof performance of the product, you may find that the battery pack tends to stick when you are trying to remove it.

6 Install the replacement battery pack.

- ① Precisely align the tabs of the battery pack, and press the battery pack up against the wall.
- ② Keep pushing the battery pack into place firmly until it moves no further.

Align the tabs.

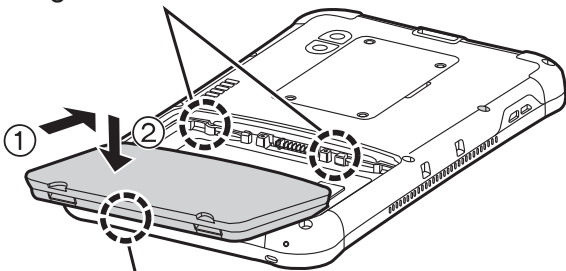

Push the bottom side of the battery pack down into position.

- Install the battery pack with the surface where its model number and other details are printed face down.

7 Engage the battery pack locks.

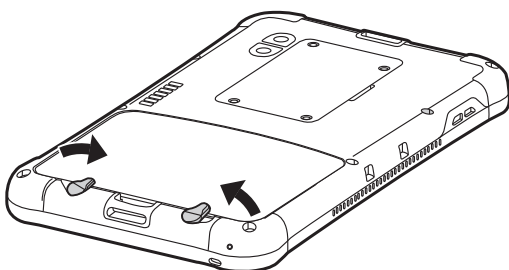

- Turn the battery pack locks until you hear a clicking sound to lock the battery pack in place.

- Do not remove the battery pack with the power still supplied to the product. Otherwise any files being written may be destroyed.
- As a safeguard to prevent operating errors, the product has a function for displaying a warning and sounding a warning beep to alert the user if you release the battery pack locks while power is still supplied to the product. If you are using headphones, for instance, the warning beep will be emitted simultaneously from the main unit and through the headphones. If the product has not been operated for the prescribed period of time, it will be placed in the sleep mode. In the sleep mode, the screen darkens and nothing appears on it, but the product continues to operate and files may be updated. At a time like this, the warning beep is emitted to alert the user if you release the battery pack locks even when the product is in the sleep mode.

Installing and removing the microSIM card

Described here are the steps to take to install and remove the microSIM card (which requires a user contract for use).

Installing the microSIM card

- 1** Insert the microSIM card straight in as far as it will go.

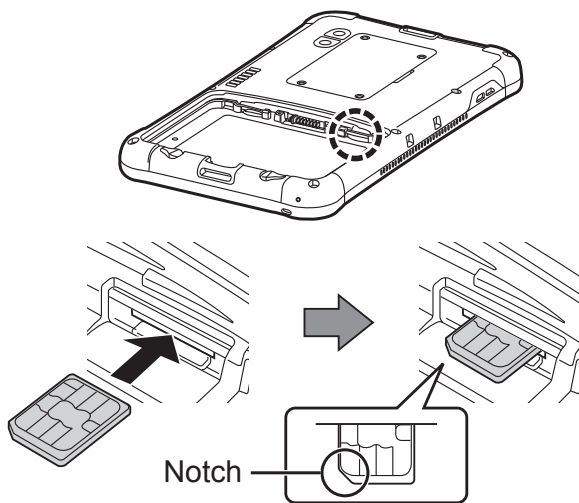

- Hold the microSIM card so that its metal terminal surface is facing up, and align its notch with the position in the figure.
- Push it firmly into place until you hear a clicking sound.

Removing the microSIM card

- 1** Press the microSIM card lightly.

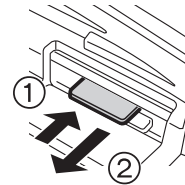

- The microSIM card will partially pop out.

- 2** Pull the microSIM card straight out.

Installing and removing the microSD memory card

Described here are the steps to take to install and remove the microSD memory card (option).

Installing the microSD memory card

- 1** Insert the microSD memory card straight in as far as it will go.

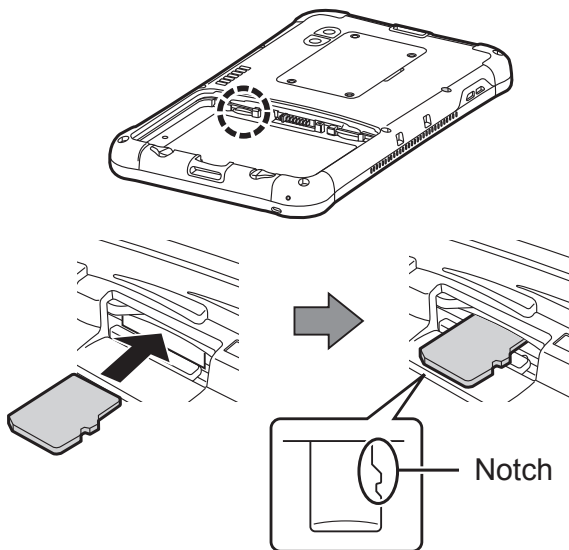

- Hold the microSD memory card so that its metal terminal surface is facing down, and align its notch with the position in the figure.
- Push it firmly into place until you hear a clicking sound.

Removing the microSD memory card

- 1** Press the microSD memory card lightly.

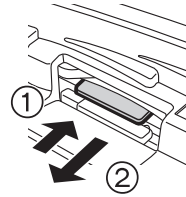





- The microSD memory card will partially pop out.

- 2** Pull the microSD memory card straight out.

Troubleshooting (basic)

Follow the instructions below when a problem has occurred. There is also an advanced troubleshooting guide in the “Reference Manual”. For a software problem, refer to the software’s instruction manual. If the problem persists, contact Panasonic Technical Support.

Starting up

<p>Cannot start up. The battery indicator is not lit.</p>	<ul style="list-style-type: none"> ● Connect the AC adaptor. ● Charge the battery pack. ● Remove the AC adaptor, then connect it again. ● Hold down  (power button) until the unit vibrates for a moment.
<p>Cannot turn on this computer. This computer does not wake up from sleep.</p>	<ul style="list-style-type: none"> ● This computer may become too hot or too cold. Leave it in an environment of 5 °C {41 °F} to 35 °C {95 °F} for about an hour, then turn on the power again.
<p>Cannot start up and the battery indicator blinks red.</p>	<ul style="list-style-type: none"> ● The remaining charge of the battery pack is less than 1 % of a full charge. Charge the pack for a while, and then turn the power on again. ● Some problem is found in the system software. Contact Panasonic Technical Support.
<p>Nothing appears on the screen.</p>	<ul style="list-style-type: none"> ● Charge the battery pack. ● Install the battery pack correctly. ● Change the battery pack which has been used with a fresh one.
<p>The date and time are incorrect.</p>	<ul style="list-style-type: none"> ● Make the correct settings by performing the following steps. <ol style="list-style-type: none"> 1. Touch  – [ Settings] – [ Date & time] and set date and time. ● If the problem persists, the internal clock battery may need to be replaced. Contact Panasonic Technical Support. ● When this computer is connected to network, check the date and time of the server. ● The 2036 A.D. or later year will not be correctly recognized on this tablet computer.
<p>Operation is slow.</p>	<ul style="list-style-type: none"> ● Ambient temperature may be high. Move this computer to the cooler location.
<p>Cannot wake up.</p>	<ul style="list-style-type: none"> ● The AC adaptor may have been disconnected and the battery pack may have become completely discharged while the product was in the sleep mode. In a case like this, any data which has not been saved will be lost, and the product will not wake up.
<p>Other startup problems</p>	<ul style="list-style-type: none"> ● Remove all peripheral devices.

Shutting down

<p>This computer does not shut down.</p>	<ul style="list-style-type: none"> • Wait one or two minutes. It is not a malfunction. • Press and hold ⏻ (power button) for 10 seconds or longer to turn the computer off forcibly. • Remove all peripherals from this computer.
---	--

Display

<p>No display</p>	<ul style="list-style-type: none"> • The power-saving function may have placed the product in the sleep mode. To resume, To wake it up, press ⏻ (power button).
<p>The screen is dark.</p>	<ul style="list-style-type: none"> • If the brightness setting of this computer is set to “Automatic brightness”, the screen brightness automatically changes depending on the ambient brightness. Disable “Automatic brightness” and change the brightness of the screen.
<p>There are red, green, or blue dots on the screen, or there is unevenness in colors and brightness on the screen.</p>	<p>The following are not malfunctions.</p> <ul style="list-style-type: none"> • Although advanced high-precision technologies are used in the production of color LCD screens, 0.002 % or less of the picture elements may be dark or remain constantly lit (i.e., more than 99.998 % of elements function properly). • Due to the natural characteristics of LCD screens, you may notice unevenness in colors and brightness depending on your angle of view. Hues may also vary by product.

Battery indicator







<p>Blinking orange.</p>	<ul style="list-style-type: none"> • The battery pack cannot be charged temporarily. Remove the AC adaptor, then connect it again.
<p>Lighting red.</p>	<ul style="list-style-type: none"> • The remaining battery charge is approximately less than 15 % of a full charge. Charge the battery pack.
<p>The battery indicator fails to light during charging.</p>	<ul style="list-style-type: none"> • Change the battery pack which has been used with a fresh one.
<p>The battery pack charging ended quickly, or the battery pack cannot be charged at all.</p>	

Troubleshooting (basic)

On-screen manual

When the screen is rotated, part of the screen is not displayed.	<ul style="list-style-type: none">• If the screen is zoomed or the menu is opened, zoom out and close the menu, then touch  to reload the data.
---	--



Others

No response	<ul style="list-style-type: none">• Press and hold  (power button) until “Power off” screen is displayed and touch [OK], then press  (power button) to turn it on.• If the application does not work normally, uninstall and reinstall the application. To uninstall:<ol style="list-style-type: none">1. Touch  – [ Settings] – [ Applications].2. Touch [DOWNLOAD] or [ALL], and touch the application to uninstall, then touch [Uninstall].3. Uninstall the application by following the on-screen instructions.
The screen freezes, and no operations can be performed.	<ul style="list-style-type: none">• Hold down  (power button) for 10 or more seconds. This forcibly turns the power off. Now turn the power back on.

Factory data reset

CAUTION

- Factory data reset function will return this computer to the default condition. When you reset this computer, the stored data will be erased.
Back up important data to other media before reset.

1. Touch  – [ Settings] – [ Backup & reset] – [Factory data reset].
All the data in /mnt/sdcard folder will be erased. The data in microSD memory card inserted into microSD memory card slot will not be erased.
2. Touch [Reset tablet].
3. Follow the on-screen instructions.

Specifications

Main specifications

		Basic Model	WAN Model		
Model No.		JT-B1APAAZAM JT-B1APAAZ** *1	JT-B1APAAAAM	JT-B1APAAVAM	JT-B1APAAU** *1
CPU/Secondary cache memory		OMAP4460 (ARM Cortex-A9 Dual Core) by TI, 1.5 GHz			
Main memory		1 GB *2 (SDRAM)			
Storage		16 GB *3 (Flash memory)			
Display method	System	TFT color LCD			
	No. of pixels	1024 × 600 (WSVGA)			
	Size	7 inches			
	No. of colors	16,777,216 colors (24 bits)			
	Backlight	White LED			
Operations	Switches	Power, application buttons			
	Touch panel	Capacitive touch panel (Multi-touch supported, 4 points)			
Communication interface	Wi-Fi	IEEE 802.11 a/b/g/n			
	Bluetooth *4	Bluetooth v4.0 + 3.0 A2DP/AVRCP/HID/HSP/OPP/SPP/GAP/PAN/HDP/BLP/HTP/HRP			
	Wireless WAN *5	—	GSM/EDGE/ UMTS HSPA/HSPA+/ LTE	CDMA EV-D0 Rev.A LTE	GSM/EDGE/ UMTS/HSPA/ HSPA+/LTE
	IC card	Contactless IC card reader/writer Type A, Type B, FeliCa			
Sensor	Accelerometer	3 axes			
	Gyro sensor	3 axes			
	Geomagnetic sensor	3 axes			
	Proximity sensor	Yes			
	Ambient light sensor	Yes			
	GPS	Yes			
Card slots	microSD memory card slot *6	microSD/microSDHC compatible (max. 32 GB) × 1			
	microSIM card slot	—	microSIM × 1		
External interface	USB *7	USB 2.0 Micro-B connector × 1 (High Speed, Host/Device *8)			
	Expansion bus connector	USB 2.0 independent connector × 1 (Full Speed, Host)			
Audio	Speaker	Internal (monaural), 500 mW (8 Ω)			
	Microphone	Internal (monaural)			
	Headset jack	Yes			
Camera	Front camera	1.3 Mega pixel, fixed focus			
	Rear camera	13 Mega pixel with LED flash, auto focus			
Power supply		AC adaptor or battery pack			
AC adaptor *9		Input: 100 V – 240 V AC, 50 Hz/60 Hz Output: 5 V DC, 1.6 A			

Specifications

Battery pack	Li-ion 3.7 V, 5720 mAh		
	Operating time ^{*10}	Approx. 8 hours	
	Charging time ^{*11}	Time taken for a 100 % charge (in sleep mode) Approx. 6 hours using the AC adaptor or USB port Approx. 4 hours using the cradle ^{*12}	
Anti-drop strength		5 feet {1.524 m} This was the value yielded by the drop tests which were carried out in accordance with our test standards: However, it should be borne in mind that the anti-drop strength rating of this product does not constitute a guarantee that the product will not be damaged or experience trouble when dropped from a height.	
Dust-tight, water-proof performance		IP65 rating satisfied ^{*13} Bear in mind that no guarantee is given for the product's dust-tight/water-proof performance when the product has been subjected to impact as a result of knocking it into objects or dropping it, for instance.	
Physical dimensions (W × D × H)		Approx. 220 mm × 130 mm × 17 mm {8.7" × 5.1" × 0.7"} (excluding protrusions)	
Weight		545 g {1.2 lb.} (including battery pack, excluding hand strap) 560 g {1.23 lb.} (including battery pack, excluding hand strap)	
Environment	Operating	Temperature	-10 °C to 50 °C {14 °F to 122 °F} (IEC60068-2-1, 2) ^{*14}
		Humidity	20 % to 80 % RH (no condensation)
	Storage	Temperature	-20 °C to 60 °C {-4 °F to 140 °F}
		Humidity	5 % to 90 % RH (no condensation)
OS ^{*15}		Android 4.0x (IceCreamSandwich)	
Pre-installed software ^{*16}		Adobe viewer, file manager, Dashboard, Device Management, User Button Manager	

*1 Varies depending on the countries.

*2 1 GB = 1,073,741,824 bytes

*3 1 GB = 1,000,000,000 bytes. Your operating system or some application will report as fewer GB. Approx. 3 GB ^{*2} is used as system area.

*4 Does not guarantee operation of all Bluetooth peripherals.

*5 Only for model with wireless WAN.

*6 This slot is compatible with High-Speed Mode. Operation has been tested and confirmed using Panasonic microSD Memory Cards with a capacity of up to 2 GB/Panasonic microSDHC Memory Cards with a capacity of up to 32 GB. Operation on other SD equipment is not guaranteed.

*7 Does not guarantee operation of all USB-compatible peripherals.

*8 Operation can be switched between Host and Device using a conversion cable.

*9 <Only for North America>

The AC adaptor is compatible with power sources up to 240 V AC adaptor. This computer is supplied with a 125 V AC compatible AC cord.

20-M-2-1

*10 Measured with LCD brightness: 60 cd/m²

Varies depending on the usage conditions, or when an optional device is attached.

*11 Varies depending on the usage conditions, CPU speed, etc.

*12 Cradle is a third-party product.

*13 In order to satisfy the dust-tight and water-proof performance of the product, install the interface cover and audio output jack cover securely.

- *14 Do not expose the skin to this product when using the product in a hot or cold environment. When using in hot or cold environment, some peripherals may fail to work properly. Check the operation environment of the peripherals.
Using this product continuously in a hot environment will shorten the product life. Avoid use in these types of environments.
When using in low temperature environment, startup may become slow or battery operation time may become short. Therefore, if you are using battery power and the remaining power is low, this computer may not start up.
- *15 An OS that has been installed at the time of purchase can be supported.
- *16 Depending on the model, some Google applications may be installed.

- microSDHC Logo is a trademark of SD-3C, LLC.
- Bluetooth® is a registered trademark of Bluetooth SIG, Inc.
- FeliCa is the contactless IC card technology developed by Sony Corporation.
FeliCa is a trademark of Sony Corporation.
- Names of products, brands, etc., appearing in this manual are trademarks or registered trademarks of their respective own companies.
- This product uses software licensed on the basis of GNU General Public License (GPL), GNU Lesser General Public License (LGPL) and other licenses. As such, this software is subject to the terms and conditions concerned. For this reason, before using the product, please read the GPL and LGPL license information indicated on the product and the information concerning the open source software.

On the home screen of the product, touch [Apps], and then check the following in sequence: [Settings] → [About tablet] → [Legal information].

The source codes approved on the basis of the GPL and LGPL terms and conditions have been released in the general domain. It should be borne in mind that these software applications are not covered by the product's warranty.

For a period of at least three (3) years after the sale of the product, Panasonic System Networks Co. will distribute at cost to those individuals or groups which have contacted it lists of the complete machine-readable source codes and copyright displays which support the GPL/LGPL software in accordance with the terms and conditions of the GPL/LGPL license agreements.

For inquiries concerning the above and for details on how to obtain the related source codes, please fill out the inquiry form which can be found on the company's web site given below.

<http://panasonic.biz/it/tablet/b1/>

- MPEG Layer-3 audio coding technology licenced Fraunhofer IIS and Thomson.
- This product is licensed under the MPEG-4 Visual Patent Portfolio License for the personal use of a consumer or other uses in which it does not receive remuneration to (i) encode video in compliance with the MPEG-4 Visual Standard ("MPEG-4 Video") and/or (ii) decode MPEG-4 Video that was encoded by a consumer engaged in a personal activity and/or was obtained from a video provider licensed to provide MPEG-4 Video. No license is granted or shall be implied for any other use. Additional information may be obtained from MPEG LA, LLC. See <http://www.mpegla.com>.
- This product is licensed under the AVC Patent Portfolio License for the personal use of a consumer or other uses in which it does not receive remuneration to (i) encode video in compliance with the AVC Standard ("AVC Video") and/or (ii) decode AVC Video that was encoded by a consumer engaged in a personal activity and/or was obtained from a video provider licensed to provide AVC Video. No license is granted or shall be implied for any other use. Additional information may be obtained from MPEG LA, LLC. See <http://www.mpegla.com>.

Options

■ Battery pack JT-B1-BT000U

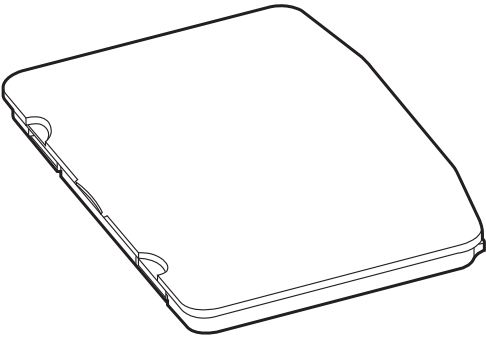

LIMITED WARRANTY

For U.S.A.

Panasonic System Communications Company of North America (PSCNA)
Computer Products - Worldwide Warranties

Section 1: Limited Warranty – Hardware

PSCNA, referred hereafter as "Panasonic" will repair the products listed below with new or rebuilt parts, free of charge in a Global Panasonic designated service location for the period specified below from the date of original purchase in the event of a defect in materials or workmanship. These warranties are extended solely to the original purchaser. A purchase receipt or other proof of date of original purchase will be required before warranty performance is rendered.

- Laptop Computers (CF-##) – 3 Years
- Ultra-Mobile PC (CF-U#/CF-H# Series) – 3 Years
- Tablet PC (FZ-A# / FZ-G# / JT-B#) – 3 Years
- PDRC - LCD & Keyboard Assembly – 3 Years

Original Battery Warranty

Batteries supplied with the product are covered under the warranty for one (1) year from date of purchase, except as excluded in Section 3. Batteries purchased separately are covered under the warranty for one (1) year from the date of purchase. A replacement battery furnished under the product warranty is covered for the remaining period of the one year warranty on the original or purchased battery.

Optional: Battery Extended Warranty Program

If this coverage is purchased, the serial numbered unit is entitled to one replacement battery within each 12 month period, providing the existing battery holds less than 50% of the original battery life. A replacement battery will be shipped out in advance for exchange on Laptop PC's and FZ-G# and JT-B# models.

On the FZ-A# series Tablet PC models, the unit must be sent in for expedited battery replacement by calling the number at the end of the last page of this document. The cost of labor, battery, and shipping are included in the price of the Battery Extended Warranty Program.

Optional: Extended Warranty Program (PC)

If this coverage is purchased, the serial numbered unit is entitled to the same warranty coverage on their unit with the exception of the battery for which a separate coverage program is available. The cost of labor, parts, and shipping are included in the price of the Extended Warranty Program.

Optional: Panasonic "Protection Plus" Warranty

Any unit for which the Panasonic "Protection Plus" warranty has been purchased will receive additional coverage for any failure that occurs due to accidental damage. All other terms and conditions of the standard warranty apply and this additional coverage will exist for the duration of the standard warranty period of the unit. If an extended Protection Plus warranty program is purchased, coverage is extended to the end of the last year of extended coverage purchased.

This warranty does not cover failures or defects that are caused by fire, intentional acts, loss, theft, improper maintenance, modification or service by anyone other than the Panasonic National Service

LIMITED WARRANTY

Center or a Panasonic Authorized Service Provider, or damage that is attributable to acts of God. Cosmetic damage that does not affect functionality is not covered. Cosmetic damage on units with hardware failures will be repaired in accordance with the warranty terms. This warranty is extended solely to the original purchaser on the unit serial number for which it was purchased. Complete unit replacement fulfills the full obligation and is at the discretion of Panasonic and is limited to once during the coverage term.

Refer to the Panasonic website for full terms and conditions on the above programs.

Wireless Module Warranty

Panasonic approved wireless modems installed in Panasonic brand computers and integrated by Panasonic or an Authorized Panasonic Wireless Integrator are covered under the warranty for the remaining warranty period of the device in which the modem is installed. For devices with less than three (3) months remaining on the unit warranty, the wireless modem will be covered for a period of three (3) months from the date of installation of the modem, covering only modem replacement or modem installation related issues.

All modems must be approved by the wireless carrier prior to use. Any use or attempted use of a wireless modem not approved and activated by the carrier for use on their network is strictly prohibited and is not sanctioned or warranted by Panasonic and may result in legal action. In addition, all modems must be approved by Panasonic as compatible with the computer hardware before installation or use.

Panasonic's sole responsibility for the warranty or technical support of the software required to install or operate the modem is defined in Section 2 (Limited Software Warranty). Any attempted software installation by anyone other than a Panasonic Authorized Wireless Integrator is not covered under warranty and may result in service charges to re-image or replace the hard drive.

Installation or attempted installation by any party other than Panasonic or an Authorized Panasonic Wireless Integrator is strictly not covered under the warranty and may void the computer warranty if damage results.

Options and Accessories Warranties

The below listed Panasonic brand or supplied options and accessories are covered under this limited warranty for the period specified from the date of purchase or as specifically stated:

- AC Adaptor / Power Cord – 3 Years
- Memory Expansion Card (Panasonic Brand) – 3 Years
- Car Mount - Docking Station PCB or Vehicle Docking Station – 3 Years
- Desktop Port Replicator, I-O Box, Docking Cradle (like CF-U1) – 3 Years
- Antenna Pass-through Cable – 3 Years
- Backlit or Full-sized keyboard – 3 Years or assumes warranty of the unit in which it is installed
- Integrated Panasonic supplied options and kits including, but not limited to Wireless Modems, Media Bay Drives (Floppy, CD, DVD, Combo), Camera, GPS, Bluetooth, Smartcard Reader, Magnetic Card Reader, Barcode Scanner, and Fingerprint Readers – 3 Years or assumes warranty period of the unit in which it is installed provided the integration was performed by Panasonic or an Authorized Integrator.
- Hard Drive / Solid State Drive (Internal) – 3 Years
- Separately purchased 2nd Hard Drive – 1 Year
- External USB Drives (CD / DVD / Floppy / Hard Drive) – 1 Year
- Optional Battery – 1 Year
- Battery Charger / Multi-Bay Battery Charger – 1 Year
- Stylus Pens, Digitizer & Standard – 90 Days (physical damage excluded)

Section 2: Limited Warranty – Software

Panasonic warrants to you only that the disk(s) or other media on which the Programs are furnished will be free from defects in material and workmanship under normal use for a period of sixty (60) days from the date of delivery thereof to you, as evidenced by your purchase receipt.

This is the only warranty Panasonic makes to you. Panasonic does not warrant that the functions contained in the Programs will meet your requirements or that the operation of the Programs will be uninterrupted or error free. Panasonic shall have no obligation for any defects in the disk(s) or other media on which the Programs are furnished resulting from your storage thereof, or for defects that have been caused by operation of the disk(s) or other media.

Panasonic's entire liability and your exclusive remedy under this warranty shall be limited to the replacement, in the United States or other Panasonic designated location, of any defective disk or other media which is returned to Panasonic's Authorized Service Center, together with a copy of the purchase receipt, within the aforesaid warranty period.

Section 3: Limited Warranty Exclusions – Specifically excluded from the warranty are:

- All consumable items; such as screen protection films, logo badges, labels, cleaning cloths, carry cases, manuals, cables, straps, belts, holsters, tethers, and harnesses and any other options and accessories not listed above or covered under a separate warranty.
- Failures related to the product operating system, hard drive or solid state drive image, software setup, software program, virus, other program(s) or file(s) on any drive or in any computer memory location.
- Failures due to BIOS settings or changes, as well as any cosmetic or physical damage to the unit.
- Any unit or device with a missing or altered model number or serial number label
- Cosmetic damage or any damage which occurs in shipment
- Failures which are caused by products not supplied by Panasonic
- Failures which result from alteration, accident, misuse, introduction of liquid or other foreign matter into the unit, abuse, neglect, installation, maladjustment of consumer controls, improper maintenance or modification, use not in accordance with product use instructions
- Failures due to service by anyone other than a Panasonic Authorized Service Provider
- Failures caused by improper installation of options or accessories or due to integration by any company other than Panasonic or a Panasonic Authorized Integrator
- Damage, failure, or loss due to the unit being stolen, lost, misplaced, or used by anyone other than the original purchaser
- Damage that is attributable to acts of God

LIMITED WARRANTY

This limited warranty only covers failures due to defects in materials or workmanship which occur during normal use. If a unit is sent to a Panasonic Authorized Service Center and no hardware failure is found, the customer will be billed for labor to correct a software issue or reimage the hard drive plus shipping and applicable administrative fees at the current rates set by the service provider.

THIS PRODUCT IS NOT INTENDED FOR USE AS OR PART OF NUCLEAR EQUIPMENT/SYSTEMS, AIR TRAFFIC CONTROL EQUIPMENT/SYSTEMS, OR AIRCRAFT COCKPIT EQUIPMENT/SYSTEMS*1. PANASONIC WILL NOT BE RESPONSIBLE FOR ANY LIABILITY RESULTING FROM THE USE OF THIS PRODUCT ARISING OUT OF THE FOREGOING USES.

*1 AIRCRAFT COCKPIT EQUIPMENT/SYSTEMS include class 2 Electronic Flight Bag (EFB) Systems and Class 1 EFB Systems when used during critical phases of flight (e.g., during take-off and landing) and/or mounted onto the aircraft. Class 1 EFB Systems and 2 EFB Systems are defined by FAA: AC (Advisory Circular) 120-76A or JAA: JAA TGL (Temporary Guidance Leaflets) No. 36.

Other Limits and Exclusions: There are no other express warranties except as listed above.

PANASONIC SHALL NOT BE LIABLE FOR LOSS OF DATA OR OTHER INCIDENTAL OR CONSEQUENTIAL DAMAGES RESULTING FROM THE USE OF THIS PRODUCT, OR ARISING OUT OF ANY BREACH OF THIS WARRANTY. ALL EXPRESS AND IMPLIED WARRANTIES, INCLUDING THE WARRANTIES OF MERCHANTABILITY AND FITNESS FOR A PARTICULAR PURPOSE ARE LIMITED TO THE APPLICABLE WARRANTY PERIOD SET FORTH ABOVE. Some states do not allow the exclusion or limitation of incidental or consequential damages, or limitations on how long an implied warranty lasts, so the above limitations or exclusions may not apply to you.

This limited warranty gives you specific legal rights, and you may also have other rights which vary from state to state. For technical support or to arrange for service on your Panasonic computer product, call our toll-free hotline at 1-855-PSC-TECH [option 1] (855-772-8324).

For Canada

PANASONIC COMPUTER AND PERIPHERALS LIMITED WARRANTY

Coverage – Panasonic Canada Inc. (“PCI”) warrants to you, the first end user customer, this computer product (excluding software media), when purchased from PCI or from a PCI authorized reseller, to be free from defects in materials and workmanship under normal use, subject to the terms set forth below, during the period of warranty coverage specified.

Scope of Coverage	Period of Coverage	Type of Failure Coverage
<ul style="list-style-type: none"> • Laptop Computers (except Battery) and AC Adaptor • Factory/PCI installed options including Wireless WAN, GPS, Bluetooth, Finger print reader, Backlit keyboard, Memory Card and Media Bay Drives (Floppy, CD/DVD) • Ultra-Mobile PC • Tablet PC • Mobile Wireless Display • PDRC – LCD and Keyboard Assemblies • Port Replicator 	Three (3) Years from Date of Original End User Customer Purchase	Defective Materials or Workmanship
<ul style="list-style-type: none"> • Battery • Battery charger • Auto Adaptor • External USB Drives 	One (1) Year from Date of Original End User Customer Purchase	Defective Materials or Workmanship
<ul style="list-style-type: none"> • Standard or Digitizer Stylus Pen 	Ninety (90) Days from Date of Original End User Customer Purchase	Defective Materials or Workmanship
<ul style="list-style-type: none"> • All consumable items including protection film, cleaning cloth, carry case, tether and harness 	No Coverage	

Remedy – In the event of a warranty claim, contact PCI’s representatives within the applicable warranty period, identifying the nature of the defect claimed, at 1-800-668-8386 between 9:00 A.M. and 5:00 P.M., Eastern Time Zone, Mon. – Fri. (excluding holidays) for instructions on how to obtain service. A purchase receipt or other proof of date of original purchase is required before warranty service is performed. Defective parts covered by this Limited Warranty will be repaired or replaced with new or comparable rebuilt parts on an exchange basis. Warranty replacement or repair is subject to the terms of this Limited Warranty for the balance of the original period of warranty coverage.

No Coverage – This Limited Warranty does not cover products purchased outside Canada. Neither does it cover damage to, failure of, or defects in a product or accessory through mishandling, improper installation, abnormal use, misuse, neglect, accident, introduction of liquid or other foreign matter into the product, alteration or servicing by anyone not authorized by PCI, or act of God.

THIS PRODUCT IS NOT INTENDED FOR USE AS, OR AS PART OF, NUCLEAR EQUIPMENT/SYSTEMS, AIR TRAFFIC CONTROL EQUIPMENT/SYSTEMS, OR AIRCRAFT COCKPIT EQUIPMENT/SYSTEMS*2. PANASONIC WILL NOT BE RESPONSIBLE FOR ANY LIABILITY RESULTING FROM THE USE OF THIS PRODUCT ARISING OUT OF THE FOREGOING USES.

LIMITED WARRANTY

- *2 AIRCRAFT COCKPIT EQUIPMENT/SYSTEMS include Class2 Electrical Flight Bag (EFB) Systems and Class1 EFB Systems when used during critical phases of flight (e.g., during take-off and landing) and/or mounted on to the aircraft. Class1 EFB Systems and 2 EFB Systems are defined by FAA: AC (Advisory Circular) 120-76A or JAA: JAA TGL (Temporary Guidance Leaflets) No.36

IF YOU SHIP THE PRODUCT FOR WARRANTY SERVICE

Carefully pack the product, preferably in the original carton. Include details of defect claimed and proof of date of original purchase. No liability is assumed for loss or damage to the product while in transit, if you chose your own transportation carrier.

SOFTWARE MEDIA LIMITED WARRANTY

Coverage – PCI warrants to you, the first end user customer, that the disk(s) or other media on which software program(s) is/are supplied will be free from defects in materials and workmanship under normal use in Canada for a period of sixty (60) days from date of receipt as evidenced by your purchase receipt for your Panasonic Computer product.

THIS IS THE ONLY WARRANTY THAT PCI MAKES RESPECTING THE SOFTWARE MEDIA. PCI does not warrant the software. Please refer to the software licensor's written warranty (accompanying the copy of the software) for any software warranty claim.

Claim Procedure – In the event of a defect in material or workmanship in the media during the sixty (60) day warranty period, and you return it, transportation costs prepaid, to Panasonic Canada Inc., Computer Products Marketing, 5770 Ambler Drive, Mississauga, Ontario L4W 2T3, within the warranty period, together with a copy of your purchase receipt, and an explanation of the suspected defect, PCI will replace in Canada the defective disk(s) or other media.

Remedy – PCI's entire liability, and your only remedy for any breach of this software media warranty is limited to replacement of the media only. It does not cover any other damages, including, but not limited to, loss of use or profit loss, or special, indirect or consequential damages, or other claims, whether or not of similar character.

No Coverage – This limited warranty does not apply if the disk(s) or other media has been used in other than a Panasonic product, or in environmental conditions other than those specified by PCI or the manufacturer, or if subjected to misuse, neglect, mishandling, modification or attempted modification of the program, or if damaged by accident or act of God. PCI is not responsible for damage to or loss of any program, data or removable storage media.

GENERAL

NO OTHER WARRANTIES – PCI DISCLAIMS ALL OTHER WARRANTIES, EITHER EXPRESS OR IMPLIED, INCLUDING, BUT NOT LIMITED TO, IMPLIED WARRANTIES OF MERCHANTABILITY AND FITNESS FOR A PARTICULAR PURPOSE, WITH RESPECT TO THE SOFTWARE, SOFTWARE MEDIA, COMPUTER PRODUCT, OPTIONS AND ACCESSORIES.

NO LIABILITY FOR CONSEQUENTIAL DAMAGES – IN NO EVENT SHALL PCI BE LIABLE FOR ANY SPECIAL, INDIRECT OR CONSEQUENTIAL DAMAGES ARISING FROM ANY BREACH OF THE LIMITED WARRANTIES SET OUT IN THIS DOCUMENT, OR FROM THE USE OF THE COMPUTER PRODUCT, INCLUDING, WITHOUT LIMITATION, LOSS OF DATA, BUSINESS, PROFIT OR GOODWILL.

IN ANY EVENT, PCI'S MAXIMUM LIABILITY FOR ANY BREACH SHALL NOT EXCEED THE AMOUNT ACTUALLY PAID BY YOU FOR THE COMPUTER PRODUCT.

NO ACTION, REGARDLESS OF ITS BASIS, MAY BE BEGUN AGAINST PCI MORE THAN TWO (2) YEARS AFTER THE CAUSE OF ACTION AROSE.

Statutory Warranties – Some jurisdictions do not allow these limitations or exclusions, so they may not apply to you.

Pour le Canada

GARANTIE LIMITÉE – ORDINATEURS ET PÉRIPHÉRIQUES PANASONIC

Couverture – Panasonic Canada Inc. (« PCI ») garantit à l'acheteur original que ce produit informatique (à l'exclusion des supports des logiciels) est, au moment de sa vente par PCI ou d'un revendeur agréé par PCI, exempt de défauts de pièces et de fabrication dans les conditions normales d'utilisation, et ce, pendant la période de couverture de la garantie, sous réserve des modalités décrites ci-dessous.

Éléments couverts	Durée de couverture	Type de couverture
<ul style="list-style-type: none">• Ordinateurs blocs-notes (sauf batteries) et adaptateur secteur• Options installées en usine/par PCI incluant : WAN sans fil, GPS, Bluetooth, lecteur d'empreintes digitales, clavier rétroéclairé, carte mémoire et lecteurs (disquettes, CD/DVD)• Ordinateurs personnels ultra-portables• Ordinateurs tablettes• Écran mobile sans fil• Ensembles PDRC – ACL et clavier• Duplicateur de port	Trois (3) ans à partir de la date d'achat original.	Défauts de pièces et de fabrication
<ul style="list-style-type: none">• Batterie• Chargeur de batterie• Adaptateur pour voiture• Périphériques USB	Un (1) an à partir de la date d'achat original.	Défauts de pièces et de fabrication
<ul style="list-style-type: none">• Stylo pointeur standard ou pour numériseur graphique	Quatre-vingt-dix (90) jours à partir de la date d'achat original.	Défauts de pièces et de fabrication
<ul style="list-style-type: none">• Tous les articles consommables incluant les pellicules protectrices, chiffons de nettoyage, étuis de transport, longes et sangles	Aucune couverture	

LIMITED WARRANTY

Recours – Pour obtenir des informations sur la marche à suivre dans le cas où une réclamation en vertu de la garantie deviendrait nécessaire, communiquez par téléphone avec un représentant de PCI au 1-800-668-8386, entre 9h00 et 17h00 (heure de l'Est) du lundi au vendredi (sauf les jours fériés), avant l'échéance de la garantie applicable, en prenant soin d'identifier la nature de la défaillance. Un reçu ou toute autre pièce justificative de la date d'achat original sera exigé avant toute réparation. Toute pièce défectueuse couverte par la présente garantie limitée sera réparée ou remplacée par une pièce neuve ou remise à neuf. Le remplacement ou la réparation sera fait conformément aux modalités de la présente garantie limitée pendant la durée restante de la période originale de la garantie.

Produits non couverts – La présente garantie limitée ne couvre pas les produits achetés à l'extérieur du Canada. Elle ne couvre pas non plus les dommages, la défaillance ou les défauts attribuables à une manutention inadéquate, une mauvaise installation, une utilisation anormale ou abusive, de la négligence, un accident, un déversement ou la pénétration d'un objet étranger, une modification, un cas fortuit ou une réparation effectuée par une personne non agréée par PCI.

CE PRODUIT N'EST PAS DESTINÉ À ÊTRE UTILISÉ, EN TOUT OU EN PARTIE, COMME SYSTÈME/ÉQUIPEMENT NUCLÉAIRE, SYSTÈME/ÉQUIPEMENT DE CONTRÔLE DU TRAFFIC AÉRIEN OU SYSTÈME/ÉQUIPEMENT DE POSTE DE PILOTAGE D'AVION*3.

PANASONIC DÉCLINE TOUTE RESPONSABILITÉ CONCERNANT L'UTILISATION DE CE PRODUIT DANS LES CAS SUSMENTIONNÉS.

*3 Les SYSTÈMES/ÉQUIPEMENTS DE POSTE DE PILOTAGE D'AVION sont dotés de systèmes OEPP (organiseur électronique de poste de pilotage) de classe 2 et de classe 1 utilisés pendant des phases critiques de vol (par exemple, pendant le décollage et l'atterrissage) et/ou montés sur l'avion. Les systèmes OEPP de classe 1 et de classe 2 sont définis par le circulaire d'information FAA: AC (Advisory Circular) 120-76A ou le feuillet n° 36 JAA: JAA TGL (Temporary Guidance Leaflets) No 36.

EXPÉDITION DU PRODUIT POUR SERVICE SOUS GARANTIE

Emballez soigneusement le produit, de préférence dans son emballage d'origine. Joignez une description de la défaillance de même qu'une pièce justificative de la date d'achat. Panasonic Canada Inc. ne peut être tenue responsable pour tout dommage ou perte subi pendant le transport si vous avez choisi le transporteur.

GARANTIE LIMITÉE – SUPPORTS DES LOGICIELS

Couverture – Panasonic Canada Inc. (« PCI ») garantit à l'acheteur original que la ou les disquettes ou tout autre support sur lequel le ou les programmes sont fournis sont exempts de défauts de pièces et de fabrication dans des conditions normales d'utilisation au Canada, et ce, pour une période de soixante (60) jours suivant la date de réception indiquée sur la preuve d'achat.

LA PRÉSENTE GARANTIE EST LA SEULE OFFERTE PAR PCI COUVRANT LES SUPPORTS DE LOGICIELS. PCI ne garantit pas les logiciels. Reportez-vous à la garantie écrite du concédant de licence d'utilisation du logiciel (qui accompagne la copie du logiciel) pour toute réclamation en vertu de la garantie.

Réclamation – marche à suivre – Panasonic Canada Inc. remplacera toute disquette ou support défectueux si l'article en question est retourné, port payé, à son service de Marketing – produits informatiques, 5770 Ambler Drive, Mississauga (Ontario) L4W 2T3, dans les soixante (60) jours suivant la date d'achat original. Joignez à votre envoi une pièce justificative de votre achat et une description du problème.

Recours – La responsabilité de PCI - et votre seul recours - dans le cas de toute défaillance couverte par la garantie sur ce support de logiciel est limitée au seul remplacement du support. Elle ne couvre aucun autre dommage, y compris, mais non exclusivement, la perte d'usage ou de profits, ni aucun dommage spécial, indirect ou consécutif, ni aucune autre réclamation de nature similaire ou autre.

Produits non couverts – La présente garantie limitée ne s'applique pas si la ou les disquettes ou autre support ont été utilisés dans un produit d'une marque autre que Panasonic ou dans des conditions environnementales autres que celles spécifiées par PCI ou le fabricant, ou soumis à une mauvaise utilisation, à la négligence, à une manutention inadéquate ou encore si le programme a été modifié ou subi une tentative de modification ou des dommages attribuables à un accident ou à un cas fortuit. De plus, PCI n'assume aucune responsabilité pour toute perte de, ou tout dommage à, un programme, des données ou un support de sauvegarde amovible.

GÉNÉRALITÉS

PCI NE RECONNAÎT AUCUNE AUTRE GARANTIE, EXPLICITE OU IMPLICITE, Y COMPRIS, MAIS NON EXCLUSIVEMENT, LES GARANTIES IMPLICITES DE VALEUR COMMERCIALE ET D'UTILITÉ À UNE FIN QUELCONQUE, À L'ÉGARD DU LOGICIEL, SUPPORTS DE LOGICIELS, PRODUITS INFORMATIQUES, PÉRIPHÉRIQUES ET ACCESSOIRES.

SOUS AUCUNE CIRCONSTANCE PCI NE POURRA ÊTRE TENUE RESPONSABLE DES DOMMAGES SPÉCIAUX, INDIRECTS OU CONSÉCUTIFS ATTRIBUABLES À UN MANQUEMENT AUX GARANTIES LIMITÉES DÉCRITES DANS LE PRÉSENT DOCUMENT OU À L'UTILISATION DU PRODUIT INFORMATIQUE, Y COMPRIS, SANS RESTRICTION, LA PERTE DE DONNÉES, D'AFFAIRES, D'ACHALANDAGE OU DE PROFIT.

DANS TOUS LES CAS, LA RESPONSABILITÉ MAXIMALE DE PCI POUR TOUT MANQUEMENT NE POURRA EXCÉDER LE PRIX DE VENTE DU PRODUIT INFORMATIQUE.

AUCUNE RÉCLAMATION, SANS ÉGARD À SES MOTIFS, NE POURRA ÊTRE FAITE AUPRÈS DE PCI PLUS DE DEUX (2) ANS APRÈS LES FAITS INVOQUÉS À LA BASE D'UNE TELLE RÉCLAMATION.

Garantie statutaires – Certaines juridictions interdisent de telles limitations ou exclusions; aussi, pourraient-elles ne pas s'appliquer.

LIMITED WARRANTY

For Europe

Panasonic System Communications Company Europe

Panasonic System Communications Company Europe (referred to as “Panasonic”) will repair this product (other than software, which is treated in a different section of this warranty) with new or refurbished parts, from the date of original purchase in the event of a defect in materials or workmanship. This warranty only applies to new Panasonic Toughbooks purchased in the EEA and Switzerland and Turkey.

Panasonic (or its authorised Service Provider) target to repair your equipment within 48 hours from its receipt in our service centre.

Additional charges may apply for shipment to countries outside of the European Union. Panasonic will use all reasonable endeavours to ensure this service.

This warranty only covers failures due to defects in materials or workmanship which occur during normal use for the applicable Service Agreement Period listed below. In the event that any product (or part thereof) is replaced, Panasonic shall transfer ownership of the replacement product (or part) to the customer and the customer shall transfer ownership of the replaced product (or part) to Panasonic.

Service Agreement Period – from original date of purchase

- Toughbooks (and every accessory included in the original packaging except the battery) – 3 years
- Toughpads (and every accessory included in the original packaging except the battery) – 3 years
- Accessories included in the original package – 3 years
- Additional peripherals manufactured by Panasonic (including media bay devices such as CD-Rom drives) – 1 year
- Batteries – 6 months. Panasonic Warranty covers the battery for six months. A battery is considered good if it maintains 50 % of its charge capacity during the warranty period. If a battery is returned under this contract and testing determines that it has charge capacity greater than 50 %, the battery will be returned with an invoice for the retail purchase price of a new battery.

This warranty is extended solely to the original purchaser. A purchase receipt or other proof of date of original purchase will be required before warranty performance is rendered.

Panasonic System Communications Company Europe

Limits and Exclusions:

This warranty does not cover and shall be void for:

- Broken or cracked LCD screen.
- Defective pixel in notebook displays and LCD screens within 0.002 %
- Damage that is attributable to fire, theft or acts of God.
- Damage caused by environmental influences (electrical storms, magnetic fields etc.).
- Damage which has not been caused during normal operation.
- Repair of damage that is cosmetic only or does not affect product functionality such as wear and tear, scratches and dents.
- Failures caused by products not supplied by Panasonic.
- Failures resulting from alteration, accidental damage, casualty, misuse, abuse or neglect.
- Introduction of liquid or other foreign matter into the unit.
- Improper installation, operation or maintenance.
- Improper connections with peripherals.
- Maladjustment of consumer controls such as function settings.
- Modification or service by anyone other than Panasonic or its approved Service Providers.
- Products used as short term rental or leased equipment.
- Products whose serial number has been removed making the unit warranty condition impossible to clearly determine.

THIS PRODUCT IS NOT INTENDED FOR USE AS, OR AS PART OF, NUCLEAR EQUIPMENT/ SYSTEMS, AIR TRAFFIC CONTROL EQUIPMENT/SYSTEMS, OR AIRCRAFT COCKPIT EQUIPMENT/SYSTEMS*4. PANASONIC WILL NOT BE RESPONSIBLE FOR ANY LIABILITY RESULTING FROM THE USE OF THIS PRODUCT ARISING OUT OF THE FOREGOING USES.

*4 AIRCRAFT COCKPIT EQUIPMENT/SYSTEMS include Class2 Electronic Flight Bag (EFB) Systems and Class1 EFB Systems when used during critical phases of flight (e.g., during take-off and landing) and/or mounted on to the aircraft. Class1 EFB Systems and 2 EFB Systems are defined by FAA: AC (Advisory Circular) 120-76A or JAA: JAA TGL (Temporary Guidance Leaflets) No.36.

There are no other express warranties except as listed above.

We strongly recommend that customers backup their data before sending back their unit to an Authorised Service Provider.

Panasonic shall not be liable for loss of data or other incidental or consequential damages resulting from the use of this product, or arising out of any breach of this warranty. All express and implied warranties, including the warranties of satisfactory quality and fitness for a particular purpose are limited to the applicable warranty period set forth above.

Panasonic shall not be liable for any indirect, special or consequential loss or damage (including without limitation any loss of profits) arising from the use of this product or for any breach of this warranty.

LIMITED WARRANTY

Panasonic System Communications Company Europe

This limited warranty gives you specific legal rights, and you may have other rights that vary from country to country.

You must consult the applicable country laws for a full determination of your rights. This limited warranty is in addition to, and does not affect any rights arising out of any contract of sale or by statute.

Data Storage Media

Data Storage Media is the media on which the Operating System, drivers and programs originally installed by Panasonic on the main unit are stored. This media is originally provided with the unit.

Panasonic warrants to you only that the disc(s) or other media on which the Programs are furnished will be free from defects in material and workmanship under normal use for a period of sixty (60) days from the date of delivery thereof to you, as evidenced by your purchase receipt.

This is the only warranty Panasonic makes to you. Panasonic does not warrant that the functions contained in the Programs will meet your requirements or that the operation of the Programs will be uninterrupted or error free.

Panasonic's entire liability and your exclusive remedy under this warranty shall be limited to the replacement of any defective disk or other media which is returned to Panasonic's authorized Service Centre, together with a copy of the purchase receipt, within the aforesaid warranty period.

Panasonic shall have no obligation for any defects in the disk(s) or other media on which the Programs are furnished resulting from your storage thereof, or for defects that have been caused by operation of the disk(s) or other media otherwise than on the Product or in the environment conditions other than those specified by Panasonic by alteration, accident, misuse, abuse, neglect, mishandling, misapplication, installation, maladjustment of consumer controls, improper maintenance, modification or damage that is attributable to acts of God. In addition, Panasonic shall have no obligation for any defects in the disk(s) or other media if you have modified, or attempted to modify any Program.

Duration of implied warranties, if any is limited to sixty (60) days.

Pre-installed software

Pre-installed software means the software shipped pre-loaded by Panasonic, not that loaded by any third party or selling agent.

Panasonic System Communications Company Europe

Panasonic and its suppliers makes no warranty, either express, implied or statutory, with respect to software provided with the Product and licensed to Purchaser, its quality, performance, merchantability, or fitness for a particular purpose.

Panasonic does not warrant that the functions contained in the software will be uninterrupted or error free.

Panasonic assumes no risk of and shall not in any case be liable for any damages, including, without limitation, any special, incidental, consequential, or punitive damages arising from breach of warranty or contract, negligence or any other legal theory, including, without limitation loss of goodwill, profits or revenue, loss of use of the Programs or Products or any associated equipment, cost of capital, cost of any substitute equipment, facilities, or services, downtime costs, or claims of any party dealing with such damages.

Some countries do not allow the exclusion or limitation of incidental or consequential damages, or limitations on how long an implied warranty lasts, so the above limitations or exclusions may not apply to you.

This limited warranty gives you specific legal rights and you may also have other rights that vary from country to country. You must consult applicable country laws for a full determination of your rights.

Contacts

Address	Panasonic System Communications Company Europe Panasonic Manufacturing U.K. Ltd. Service Centre Building B4, Wyncliffe Road, Pentwyn Industrial Estate, Cardiff, United Kingdom CF23 7XB
Web page	http://www.toughbook.eu/
Helpdesk	
English speaking service	+44 (0) 8709 079 079
French speaking service	+33 (0) 1 47 91 64 99
German speaking service	+49 (0) 1805 410 930
Italian speaking service	+39 (0) 848 391 999
Spanish speaking service	+34 (0) 901 101 157
E-mail address	toughbooksupport@eu.panasonic.com
Czech speaking service	+420 (0) 800 143234
Hungarian speaking service	+36 (0) 6800 163 67
Polish speaking service	+48 (0) 800 4911558
Romanian speaking service	+40 (0) 800 894 743
Slovakian speaking service	+421 (0) 800 42672627
E-mail address	toughbooksupport@csg.de
Payments	toughbookservicepayments.cardiff@eu.panasonic.com

Panasonic System Networks Co., Ltd.

1-62, 4-chome, Minoshima, Hakata-ku, Fukuoka 812-8531, Japan

Panasonic System Communications Company of North America

3 Panasonic Way, Panazip 2F-5,
Secaucus, NJ 07094

Panasonic Canada Inc.

5770 Ambler Drive, Mississauga,
Ontario L4W 2T3

Importer's name & address pursuant to the EU GPSD (General Product Safety Directive)
2001/95/EC Art.5

Panasonic System Communications Company Europe,

Panasonic Marketing Europe GmbH

Hagenauer Straße 43
65203 Wiesbaden
Germany

Web site : <http://panasonic.net/>

© Panasonic System Networks Co., Ltd. 2013

Printed in Japan

F0113-0

PGQX1334ZA/J1

