

OPERATING INSTRUCTIONS

Personal Computer

Model No. **FZ-G1** series

Contents

Read Me First

Safety Precautions	2
Regulatory Information	7

Getting Started

Introduction.....	13
Description of Parts	15
First-time Operation.....	17
Turning On / Turning Off.....	23

Useful Information

Handling and Maintenance.....	24
Installing Software	28

Troubleshooting

Troubleshooting (Basic).....	33
------------------------------	----

Appendix

LIMITED USE LICENSE AGREEMENT	39
Specifications	41
Standard Limited Warranty.....	46

Read Me First

Getting Started

Useful Information

Troubleshooting

Appendix

Safety Precautions

To reduce the risk of injury, loss of life, electric shock, fire, malfunction, and damage to equipment or property, always observe the following safety precautions.

Explanation of symbol word panels

The following symbol word panels are used to classify and describe the level of hazard, injury, and property damage caused when the denotation is disregarded and improper use is performed.

DANGER

Denotes a potential hazard that will result in serious injury or death.

WARNING

Denotes a potential hazard that could result in serious injury or death.





CAUTION

Denotes a hazard that could result in minor injury.

NOTICE

Denotes a hazard that could result in property damage.

The following symbols are used to classify and describe the type of instructions to be observed.

    These symbols are used to alert users to a specific operating procedure that must not be performed.

 This symbol is used to alert users to a specific operating procedure that must be followed in order to operate the unit safely.

DANGER

Precautions on the Battery Pack

 **Do Not Throw the Battery Pack into a Fire or Expose It to Excessive Heat**
Generation of heat, ignition or rupture may result.

 **Do Not Insert Sharp Objects Into the Battery Pack, Disassemble, or Modify It**
Electrolyte leakage, generation of heat, ignition or rupture may result.

 **Do Not Short the Positive (+) and Negative (-) Contacts**
Generation of heat, ignition or rupture may result.

- Do not place the battery pack together with articles such as necklaces or hairpins when carrying or storing.

 **Avoid Extreme Heat (Near the Fire, in Direct Sunlight, for Example)**
Electrolyte leakage, generation of heat, ignition or rupture may result.

 **Do Not Apply Shocks to the Product by Dropping It, Applying Strong Pressure to It, etc.**
Electrolyte leakage, generation of heat, ignition or rupture of the battery may result.

- If this product is subjected to a strong impact, damaged or deformed, stop using it immediately.

 **Do Not Charge the Battery Using Methods Other Than Those Specified**
If the battery is not charged using one of the specified methods, electrolyte leakage, generation of heat, ignition or rupture may result.

 **When the Battery Pack Has Deteriorated, Replace It With a New One**
Continued use of a damaged battery pack may result in heat generation, ignition or battery rupture.



DANGER

Precautions on the Battery Pack



Do Not Use with Any Other Product

The battery pack is rechargeable and was intended for the specified product. If it is used with a product other than the one for which it was designed, electrolyte leakage, generation of heat, ignition or rupture may result.



Do Not Use This Product with a Battery Pack Other Than the One Specified

Use only the specified battery pack (→ page 17) with your product. Use of battery packs other than those manufactured and supplied by Panasonic may present a safety hazard (generation of heat, ignition or rupture).



WARNING



If a Malfunction or Trouble Occurs, Immediately Stop Use

If a Malfunction Occurs, Immediately Unplug the AC Plug and the Battery Pack

- This product is damaged
- Foreign object inside this product
- Smoke emitted
- Unusual smell emitted
- Unusually hot

Continuing to use this product while any of the above conditions are present may result in fire or electric shock

- If a malfunction or trouble occurs, immediately turn the power off and unplug the AC plug, and then remove the battery pack. Then contact your technical support office for repair.



Do Not Touch This Product in a Thunderstorm If Connected with the AC Cable or Any Other Cables

Electric shock may result.



Do Not Connect the AC Adaptor to a Power Source Other Than a Standard Household AC Outlet

Otherwise, a fire due to overheating may result. Connecting to a DC/AC converter (inverter) may damage the AC adaptor. On an airplane, only connect the AC adaptor/charger to an AC outlet specifically approved for such use.



Do Not Pull or Insert the AC Plug If Your Hands Are Wet

Electric shock may result.



Clean Dust and Other Debris of the AC Plug Regularly

If dust or other debris accumulates on the plug, humidity, etc. may cause a defect in the insulation, which may result in a fire.

- Pull the plug, and wipe it with a dry cloth.
- Pull the plug if the computer is not being used for a long period of time.



Insert the AC Plug Completely

If the plug is not inserted completely, fire due to overheating or electric shock may result.

- Do not use a damaged plug or loose AC outlet.



Close the Connector Cover Tightly When Using This Product Where Is a Lot of Water, Moisture, Steam, Dust, Oily Vapors, etc.

The entry of foreign matter may cause a fire or electric shocks.

- If foreign matter has found its way inside, immediately turn the power off and unplug the AC cord, and then remove the battery pack. Then contact your technical support office.







Do Not Disassemble This Product

You may receive an electric shock, or foreign matter may enter and result in a fire.



Read Me First







Safety Precautions

WARNING

	Do Not Turn the Volume Up to Loud When Using Headphones Listening at high volumes that overstimulate the ear for long periods of time may result in loss of hearing.
	Do Not Use with Exposing the Skin to This Product for a Long Period of Time Using this product with exposing the skin to the heat source of this product or AC adaptor for a long period of time can cause a low-temperature burn.
	Do Not Do Anything That May Damage the AC Cord, the AC Plug, or the AC Adaptor Do not damage or modify the cord, place it near hot tools, bend, twist, or pull it forcefully, place heavy objects on it, or bundle it tightly. Continuing to use a damaged cord may result in fire, short circuit, or electric shock.
	Do Not Expose Yourself to the Hot Wind from the Ventilation Hole (Exhaust) For a Long Period of Time Low-temperature burns may result. Covering the ventilation hole (exhaust) with your hand or other object can cause heat to build up inside, possibly resulting in burns.

CAUTION

	Do Not Place This Product on Unstable Surface If balance is lost, this product may fall over or drop, resulting in an injury.
	Avoid Stacking If balance is lost, this product may fall over or drop, resulting in an injury.

	Do Not Leave This Product in High Temperature Environment for a Long Period of Time Leaving this product where it will be exposed to extremely high temperatures such as near fire or in direct sunlight may deform the cabinet and/or cause trouble in the internal parts. Continued use in such a resulting condition may lead to short-circuiting or insulation defects, etc. which may in turn lead to a fire or electric shocks.
	Do Not Block the Ventilation Hole (Exhaust/Intake) Using this product wrapped in cloth or on top of bedding or a blanket can block the ventilation hole and cause heat to build up inside, possibly resulting in a fire.
	Hold the Plug When Unplugging the AC Plug Pulling on the cord may damage the cord, resulting in a fire or electric shock.
	Do Not Move This Product While the AC Plug Is Connected The AC cord may be damaged, resulting in fire or electric shock. <ul style="list-style-type: none"> • If the AC cord is damaged, unplug the AC plug immediately.
	Use Only the Specified AC Adaptor With This Product Using an AC adaptor other than the one supplied (supplied with the unit or one sold separately as an accessory) may result in a fire.
	Do Not Subject the AC Adaptor to Any Strong Impact Using the AC adaptor after a strong impact such as being dropped may result in electric shock, short circuit, or fire.
	Take a Break of 10-15 Minutes Every Hour Using this product for long periods of time may have detrimental health effects on the eyes or hands.

Read Me First



CAUTION



<Only for model with LAN port>
Do Not Connect a Telephone Line, or a Network Cable Other Than the One Specified, into the LAN Port

If the LAN port is connected to a network such as the ones listed below, a fire or electric shock may result.

- Networks other than 1000BASE-T, 100BASE-TX or 10BASE-T
- Phone lines (IP phone (Internet Protocol Telephone), Telephone lines, internal phone lines (on-premise switches), digital public phones, etc.)



Do Not Expose the Skin to This Product When Using the Product In a Hot or Cold Environment

Burns, low-temperature burns or frostbite may result.

- When it is necessary to expose the skin to this product such as to scan a fingerprint, perform the operation in the shortest time possible.

NOTICE

- Do not place the computer near a television or radio receiver.
- Keep the computer away from magnets. Data stored on the flash memory may be lost.
- This computer is not intended for the display of images for use in medical diagnosis.
- This computer is not intended for a use with connection of medical equipment for the purpose of medical diagnosis.
- Panasonic shall not be liable for loss of data or other incidental or consequential damages resulting from the use of this product.
- Do not touch the terminals on the battery pack. The battery pack may no longer function properly if the contacts are dirty or damaged.
- Do not expose the battery pack to water, or allow it to become wet.
- If the battery pack will not be used for a long period of time (a month or more), charge or discharge (use) the battery pack until the remaining battery level becomes 30% to 40% and store it in a cool, dry place.
- This computer prevents overcharging of the battery by recharging only when the remaining power is less than approx. 95% of capacity.
- The battery pack is not charged when the computer is first purchased. Be sure to charge it before using it for the first time. When the AC adaptor is connected to the computer, charging begins automatically.
- Should the battery leak and the fluid get into your eyes, do not rub your eyes. Immediately flush your eyes with clear water and see a doctor for medical treatment as soon as possible.

NOTE

- The battery pack may become warm during recharging or normal use. This is completely normal.
- Recharging will not commence if internal

Safety Precautions

temperature of the battery pack is outside of the allowable temperature range (0 °C to 50 °C). (→  *Reference Manual* “Battery Power”) Once the allowable range requirement is satisfied, charging begins automatically. Note that the recharging time varies based on the usage conditions. (Recharging takes longer than usual when the temperature is 10 °C or below.)

- If the temperature is low, the operating time is shortened. Only use the computer within the allowable temperature range.
- This computer has a high temperature mode function that prevents the degradation of the battery in high temperature environments. (→  *Reference Manual* “Battery Power”) A level corresponding to a 100% charge for high temperature mode is approximately equivalent to an 80% charge level for normal temperature mode.
- The battery pack is a consumable item. If the amount of time the computer can be run by using a particular battery pack becomes dramatically shorter and repeated recharging does not restore its performance, the battery pack should be replaced with a new one.
- When transporting a spare battery inside a package, briefcase, etc., it is recommended that it be placed in a plastic bag so that its contacts are protected.
- Always power off the computer when it is not in use. Leaving the computer on when the AC adaptor is not connected will exhaust the remaining battery capacity.

THIS PRODUCT IS NOT INTENDED FOR USE AS, OR AS PART OF, NUCLEAR EQUIPMENT/SYSTEMS, AIR TRAFFIC CONTROL EQUIPMENT/SYSTEMS, AIRCRAFT COCKPIT EQUIPMENT/SYSTEMS^{*1}, MEDICAL DEVICES OR ACCESSORIES^{*2}, LIFE SUPPORT SYSTEMS OR OTHER EQUIPMENTS/DEVICES/SYSTEMS THAT ARE INVOLVED WITH ENSURING HUMAN LIFE OR SAFETY. PANASONIC WILL NOT BE RESPONSIBLE FOR ANY LIABILITY RESULTING FROM THE USE OF THIS PRODUCT ARISING OUT OF THE FOREGOING USES.

^{*1} AIRCRAFT COCKPIT EQUIPMENT/SYSTEMS include Class2 Electronic Flight Bag (EFB) Systems and Class1 EFB Systems when used during critical phases of flight (e.g., during take-off and landing) and/or mounted on to the aircraft. Class1 EFB Systems and 2 EFB Systems are defined by FAA: AC (Advisory Circular) 120-76A or JAA: JAA TGL (Temporary Guidance Leaflets) No.36.

^{*2} As defined by the European Medical Device Directive (MDD) 93/42/EEC.

Panasonic cannot guarantee any specifications, technologies, reliability, safety (e.g. Flammability/Smoke/Toxicity/Radio Frequency Emission, etc) requirements related to aviation standards that exceed the specifications of our COTS (Commercial-Off-The-Shelf) products.

Regulatory Information

Information to the User

<Only for model with wireless LAN/Bluetooth>

This product and your Health

This product, like other radio devices, emits radio frequency electromagnetic energy. The level of energy emitted by this product however is far much less than the electromagnetic energy emitted by wireless devices like for example mobile phones.

Because this product operates within the guidelines found in radio frequency safety standards and recommendations, we believe this product is safe for use by consumers. These standards and recommendations reflect the consensus of the scientific community and result from deliberations of panels and committees of scientists who continually review and interpret the extensive research literature.

In some situations or environments, the use of this product may be restricted by the proprietor of the building or responsible representatives of the organization. These situations may for example include:

- Using this product on board of airplanes, or
- In any other environment where the risk of interference to other devices or services is perceived or identified as harmful.

If you are uncertain of the policy that applies on the use of wireless devices in a specific organization or environment (e.g. airports), you are encouraged to ask for authorization to use this product prior to turning on the product.

Regulatory Information

We are not responsible for any radio or television interference caused by unauthorized modification of this product. The correction of interference caused by such unauthorized modification will be the responsibility of the user. We and its authorized resellers or distributors are not liable for damage or violation of government regulations that may arise from failing to comply with these guidelines.

26-M-1

Regulatory Information

Regulations for Wireless LAN / Bluetooth

<Only for model with wireless LAN/Bluetooth>

Country / Region	802.11a	802.11b/g Bluetooth
Austria, Belgium, Croatia, Cyprus, Czech Republic, Denmark, Estonia, Finland, France, Germany, Greece, Hungary, Iceland, Ireland, Latvia, Lithuania, Luxembourg, Macedonia, Malta, Netherlands, Poland, Portugal, Slovakia, Slovenia, Spain, Sweden, Switzerland, United Kingdom	Restricted to indoor use.	
Italy	Restricted to indoor use. General authorization required if used outside.	General authorization required if used outside of own premises.
Turkey	Restricted to indoor use. Prohibited within an 1 km radius from the centre of the runway of the airports.	
Norway	Restricted to indoor use.	Prohibited within a 20 km radius from the centre of Ny-Ålesund.

- The latest version of “ERC RECOMMENDATION 70-03” by European Radiocommunications Committee and the regulation in Turkey.
- Use only the antenna specified by Panasonic.
- Confirm the latest information to the radio regulation authorities.

40-E-1

Lithium Battery

Lithium Battery!

This computer contains a lithium battery to enable the date, time, and other data to be stored. The battery should only be exchanged by authorized service personnel.

Warning!

A risk of explosion from incorrect installation or misapplication may possibly occur.

15-E-1

Information for Users on Collection and Disposal of Old Equipment and used Batteries



These symbols on the products, packaging, and/or accompanying documents mean that used electrical and electronic products and batteries should not be mixed with general household waste. For proper treatment, recovery and recycling of old products and used batteries, please take them to applicable collection points, in accordance with your national legislation and the Directives 2002/96/EC and 2006/66/EC. By disposing of these products and batteries correctly, you will help to save valuable resources and prevent any potential negative effects on human health and the environment which could otherwise arise from inappropriate waste handling. For more information about collection and recycling of old products and batteries, please contact your local municipality, your waste disposal service or the point of sale where you purchased the items. Penalties may be applicable for incorrect disposal of this waste, in accordance with national legislation.



For business users in the European Union

If you wish to discard electrical and electronic equipment, please contact your dealer or supplier for further information.

[Information on Disposal in other Countries outside the European Union]

These symbols are only valid in the European Union. If you wish to discard this product, please contact your local authorities or dealer and ask for the correct method of disposal.



Note for the battery symbol (bottom two symbol examples):

This symbol might be used in combination with a chemical symbol. In this case it complies with the requirement set by the Directive for the chemical involved.

53-E-1

Safety Precautions

<Only for model with wireless WAN>

The following safety precautions must be observed during all phases of the operation, usage, service or repair of any Personal Computer or Handheld Computer incorporating wireless WAN modem. Manufacturers of the cellular terminal are advised to convey the following safety information to users and operating personnel and to incorporate these guidelines into all manuals supplied with the product. Failure to comply with these precautions violates safety standards of design, manufacture and intended use of the product. Panasonic assumes no liability for customer failure to comply with these precautions.



When in a hospital or other health care facility, observe the restrictions on the use of mobiles. Switch Personal Computer or Handheld Computer incorporating wireless WAN modem off, if instructed to do so by the guidelines posted in sensitive areas. Medical equipment may be sensitive to RF energy.

The operation of cardiac pacemakers, other implanted medical equipment and hearing aids can be affected by interference from Personal Computer or Handheld Computer incorporating wireless WAN modem placed close to the device. If in doubt about potential danger, contact the physician or the manufacturer of the device to verify that the equipment is properly shielded. Pacemaker patients are advised to keep their Personal Computer or Handheld Computer incorporating wireless WAN modem away from the pacemaker, while it is on.

Regulatory Information



Switch off Personal Computer or Handheld Computer incorporating wireless WAN modem before boarding an aircraft. Make sure it cannot be switched on inadvertently. The operation of wireless appliances in an aircraft is forbidden to prevent interference with communications systems. Failure to observe these instructions may lead to the suspension or denial of cellular services to the offender, legal action, or both.

For details on usage of this unit in aircrafts please consult and follow instruction provided by the airline.



Do not operate Personal Computer or Handheld Computer incorporating wireless WAN modem in the presence of flammable gases or fumes. Switch off the cellular terminal when you are near petrol stations, fuel depots, chemical plants or where blasting operations are in progress. Operation of any electrical equipment in potentially explosive atmospheres can constitute a safety hazard.



Your Personal Computer or Handheld Computer incorporating wireless WAN modem receives and transmits radio frequency energy while switched on. Remember that interference can occur if it is used close to TV sets, radios, computers or inadequately shielded equipment. Follow any special regulations and always switch off Personal Computer or Handheld Computer incorporating wireless WAN modem wherever forbidden, or when you suspect that it may cause interference or danger.



Road safety comes first! Do not use a Personal Computer or Handheld Computer incorporating wireless WAN modem while driving a vehicle. Do not place the computer with wireless WAN modem in an area where it could cause personal injury to the driver or passengers. It is recommended to stow the unit in the boot or secure stowage area while driving.

Do not place the computer with wireless WAN modem in an area over an air bag or in the vicinity where an air bag may deploy.

Air bags inflate with great force and if the computer with wireless WAN modem is placed in the air bag deployment area may be propelled with great force and cause serious injury to occupants of the vehicle.



SOS

IMPORTANT!

Personal Computer or Handheld Computer incorporating wireless WAN modem operate using radio signals and cellular networks cannot be guaranteed to connect in all conditions. Therefore, you should never rely solely upon any wireless device for essential communications, for example emergency calls.

Remember, in order to make or receive calls, Personal Computer or Handheld Computer incorporating wireless WAN modem must be switched on and in a service area with adequate cellular signal strength.

Some networks do not allow for emergency calls if certain network services or phone features are in use (e.g. lock functions, fixed dialing etc.). You may need to deactivate those features before you can make an emergency call.

Some networks require that a valid SIM card be properly inserted in Personal Computer or Handheld Computer incorporating wireless WAN modem.

CAUTION:

Risk of Explosion if Battery is replaced by an Incorrect Type. Dispose of Used Batteries According to the Instructions.

58-E-1

Interface Cable

Use of an interface cable longer than 3 m (9.84 feet) is not recommended.

11-E-1

Camera Light

<For model with rear camera>

CAUTION

- The light from the LED is strong and can injure human eyes. Do not look directly at the LEDs with naked eyes.

57-E-1

For Europe



<Only for model with a “CE Ⓢ” mark on the bottom of the computer>

Declaration of Conformity (DoC)

“Hereby, Panasonic declares that this Personal Computer is in compliance with the essential requirements and other relevant provisions of the Directive 1999/5/EC.”

Hint:

If you want to get a copy of the original DoC of our above mentioned products, please contact our web address: <http://www.doc.panasonic.de>

Authorised Representative:

Panasonic Testing Centre
Panasonic Marketing Europe GmbH
Winsbergring 15, 22525 Hamburg, Germany

Indication of the countries where WLAN is intended to be used:

AT BE BG CH CY CZ DE DK EE ES
FI FR GB GR HU IE IS IT LT LU
LV MT NL NO PL PT RO SE SI SK TR

18-25-E-0

<Only for model with a “CE” mark on the bottom of the computer>



Declaration of Conformity (DoC)

“Hereby, Panasonic Corporation declares that this Personal Computer is in compliance with the essential requirements and other relevant provisions of Eu Council Directives.”

Authorised Representative:

Panasonic Testing Centre
Panasonic Marketing Europe GmbH
Winsbergring 15, 22525 Hamburg, Germany

18-E-0

For Used in Motor Vehicle

Warning: Check the following Commission Recommendation to determine proper installation and usage of this product while operating within a motor vehicle.

“Commission Recommendation on safe and efficient in-vehicle information and communication systems: A European statement of principles on human machine interface.”

Commission Recommendation is available from Official Journal of the European Communities.

35-E-1

When using Port Replicator or Car Mounter on which an external antenna can be installed:

- External antenna for wireless LAN must be professionally installed.
- The gain of external antenna for wireless LAN must not exceed 5dBi.
- The user must maintain minimum of 20 cm spacing between the external antenna and all people (excluding extremities of hands, wrist and feet) during wireless modes of operation.

41-E-1-1

Regulatory Information

For UK

For your safety, please read the following text carefully.

This appliance is supplied with a molded three pin mains plug for your safety and convenience. A 3 ampere fuse is fitted in this plug.

Should the fuse need to be replaced please ensure that the replacement fuse has a rating of 3 ampere and that it is approved by ASTA or BSI to BS1362.

Check for the ASTA mark  or the BSI mark  on the body of the fuse.

If the plug contains a removable fuse cover you must ensure that it is refitted when the fuse is replaced.

If you lose the fuse cover the plug must not be used until a replacement cover is obtained. A replacement fuse cover can be purchased from your local dealer.

If the fitted molded plug is unsuitable for the socket outlet in your home then the fuse should be removed and the plug cut off and disposed of safely.

There is a danger of severe electrical shock if the cut off plug is inserted into any 13-ampere socket.

How to replace the fuse

The location of the fuse differs according to the type of AC mains plug (figures A and B). Confirm the AC mains plug fitted and follow the instructions below. Illustrations may differ from actual AC mains plug.

Open the fuse cover with a screwdriver and replace the fuse and close or attach the fuse cover.

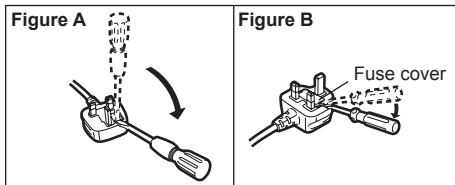

8-E-1

For Turkey / Turkiye için.

EEE complies with Directive of Turkey.

EEE Yönetmeliğine Uygundur.

For India



For the purpose of recycling to facilitate effective utilization of resources, please return this product to a nearby authorized collection center, registered dismantler or recycler, or Panasonic service center when disposing of this product.

Please see the Panasonic website for further information on collection centers, etc.

<http://www.panasonic.co.in/wps/portal/home>

68-M-1

For Australia

For Used in Motor Vehicle

Warning: Notebook Computer may be installed in a motor vehicle and visible to the driver only if used to support vehicle related functions such as vehicle information, system control, rear or side observation and navigation. If the Notebook Computer is to be used for work or entertainment purposes, such as television reception, video play or other work programs, it must be installed in a position where it will NOT:

(a) be visible, directly or indirectly, to the operator of the motor vehicle; or

(b) cause distraction to drivers of other motor vehicles.

Check with individual state laws to determine lawful use of this product while operating within a motor vehicle. If the visual display unit is, or is part of, a driver's aid, above rule is not applied. "Driver's aid" includes closed-circuit television security cameras, dispatch systems, navigational or intelligent highway and vehicle system equipment, rear view screens, ticket-issuing machines and vehicle monitoring devices.

35-A-1

Introduction







Thank you for purchasing this Panasonic product. For optimum performance and safety, please read these instructions carefully.

In these instructions, the names are referred as follows.

Windows 8 indicates Windows® 8 Operating System.

Windows 7 indicates Windows® 7 Operating System.

■ Terms and illustrations in these instructions

CAUTION :	Conditions that may result in minor or moderate injury.
NOTE :	Useful and helpful information.
Enter :	Press [Enter] key.
Alt + Del :	Press and hold [Alt] key, and then press [Del] key.
 :	Page in these Operating Instructions or in the Reference Manual.
 :	Reference to the on-screen manuals.
Windows 8 Display “Charm”	Flick from right side to inside of the screen.
Touch [Charm] -  :	This illustration means to touch  (Settings) in the Charm menu.
Windows 7  (Start) - [All Programs] :	Touch  (Start), and then touch [All Programs].

- Some illustrations are simplified to help your understanding and may look different from the actual unit.
- If you do not log on as an administrator, you cannot use some functions or cannot display some screens.
- Refer for the latest information about optional products to the catalogs, etc.
- In these instructions, the names and terms are referred as follows.
 - “Windows® 8 Pro 64-bit” as “Windows” or “Windows 8”
 - “Windows® 7 Professional 32-bit Service Pack 1” and “Windows® 7 Professional 64-bit Service Pack 1” as “Windows” or “Windows 7”
 - DVD MULTI drive as “DVD drive”
 - “Multilingual User Interface” as “MUI”
- **Windows 8**
Screen messages are explained in [English (United States)].
(Depending on the language preference, some screen messages in these instructions are different from the actual screen messages. For example, [Flight mode] may be displayed instead of [Airplane mode] in some language preference)

■ Disclaimer

Computer specifications and manuals are subject to change without notice. Panasonic Corporation assumes no liability for damage incurred directly or indirectly from errors, omissions or discrepancies between the computer and the manuals.

■ Trademarks

Microsoft®, Windows®, and the Windows logo are registered trademarks of Microsoft Corporation of the United States and/or other countries.

Intel, Core, Centrino and PROSet are either registered trademarks or trademarks of Intel Corporation.

microSDXC Logo is a trademark of SD-3C, LLC.



Introduction

Adobe, the Adobe logo and Adobe Reader are either registered trademarks or trademarks of Adobe Systems Incorporated in the United States and/or other countries. Bluetooth® is a registered trademark owned by Bluetooth SIG, Inc., U.S.A. and licensed to Panasonic Corporation. HDMI, the HDMI Logo and High-Definition Multimedia Interface are trademarks or registered trademarks of HDMI Licensing LLC in the United States and other countries. Names of products, brands, etc., appearing in this manual are trademarks or registered trademarks of their respective own companies.

■ On-screen Manual

For further information about the computer, you can refer to the on-screen manual.

● Reference Manual

The Reference Manual contains the practical information to help you fully enjoy the computer's performance.

● Important Tips

The Important Tips will provide you with the battery information so that you can use the battery pack in the optimum condition to obtain longer operation time.

To access the on-screen manuals, follow the steps below.

Windows 8

On the Start screen, touch the [Manual Selector] tile, and select the on-screen manual.

Windows 7

Double-touch [Manual Selector] on the desktop screen, and select the on-screen manual.

Description of Parts

Front side

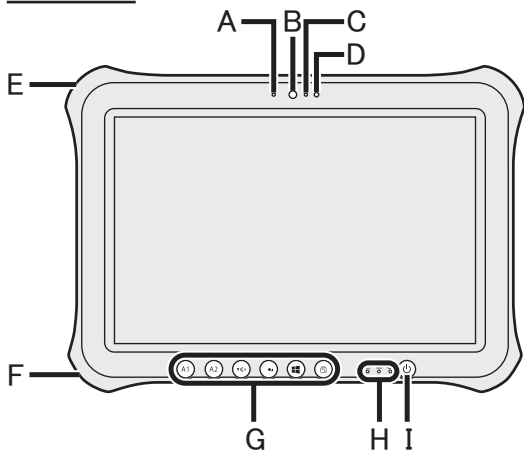

Right side

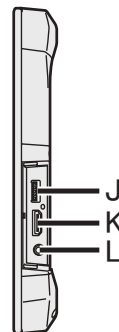

Front Camera

→ *Reference Manual* "Camera"

A: Camera Indicator

B: Camera Lens

C: Microphone

D: Ambient Light Sensor

The ambient light sensor is equipped with an automatic brightness adjustment function that adjusts the display screen. (→ page 25)

E: Security lock

A Kensington cable can be connected.

For further information, read the manual that comes with the cable.

F: DC-IN jack

G: Tablet Buttons

→ *Reference Manual* "Tablet Buttons"

H: LED Indicator

: Power Indicator

Off : Power off/Hibernation, Green:

Power on, Blinking green: Sleep

: Drive status

: Battery status

→ page 25 "When the battery indicator does not light on"

→ *Reference Manual* "Battery Power"

I: Power Switch

J: USB3.0 Port

→ *Reference Manual* "USB Devices"

K: HDMI Port

→ *Reference Manual* "External Display"

L: Headset Jack

A headset or headphone can be connected.

Description of Parts

Rear side

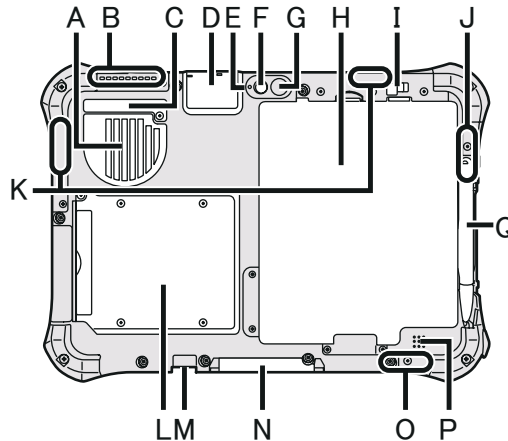

A: Ventilation Hole (Intake)

B: Ventilation Hole (Exhaust)

C: Dust Cover

→ page 27 “To clean inside of the dust cover”

D: USB2.0 Port^{*1} / LAN Port^{*2} / Serial Port^{*3} / MicroSD Memory Card Slot^{*4}

^{*1} Only for model with USB2.0 port

→ Reference Manual “USB Devices”

^{*2} Only for model with LAN port

→ Reference Manual “LAN”

^{*3} Only for model with Serial port

→ Reference Manual “Serial Port”

^{*4} Only for model with microSD memory card slot

→ Reference Manual “MicroSD Memory Card”

Rear Camera

<Only for model with Rear Camera>

→ Reference Manual “Camera”

E: Camera Indicator

F: Camera Lens

G: Camera light

H: Battery Pack

→ Reference Manual “Battery Power”

I: Battery Latch

→ Reference Manual “Battery Power”

J: Wireless LAN Antenna

<Only for model with wireless LAN>

→ Reference Manual “Wireless LAN”

K: Wireless WAN Antenna

<Only for model with Wireless WAN>

→ Reference Manual “Wireless WAN”

L: Smart Card Slot

<Only for model with Smart Card Slot>

→ Reference Manual “Smart Card”

M: External Antenna Connector

N: Expansion Bus Connector

→ Reference Manual “Cradle”

O: Wireless LAN Antenna / Bluetooth Antenna

<Only for model with wireless LAN>

<Only for model with Bluetooth>

→ Reference Manual “Wireless LAN”
“Bluetooth”

P: Speaker

→ Reference Manual “Dashboard for Panasonic PC”

Q: Pen Holder

First-time Operation

■ Preparation

① Check and identify the supplied accessories.

If you do not find the described accessories, contact Panasonic Technical Support.

- AC Adaptor . . . 1
- AC Cord 1
- Battery Pack 1
- Digitizer pen 1

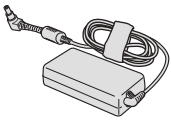

Model No: CF-AA6413C

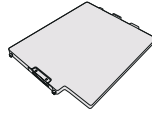

Model No: FZ-VZSU84U



→ Reference Manual "Screen Input Operation"

- Tether 1
- Soft Cloth 1

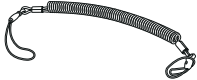

→ Reference Manual "Screen Input Operation"

- OPERATING INSTRUCTIONS (This book) 1

② Read the LIMITED USE LICENSE AGREEMENT before breaking the seal on the computer's packaging (→ page 39).

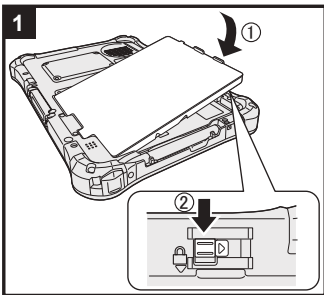

1 Inserting the Battery Pack.

Turn over the computer and insert the battery pack until it touch to the secured position.

- Make sure no foreign objects are under the computer.

CAUTION

- Make sure the latch is securely locked. Otherwise the battery pack may fall when you carry the computer.
- Do not touch the terminals of the battery pack and the computer. Doing so can make the terminals dirty or damaged, and may cause malfunction of the battery pack and the computer.

NOTE

- Note that the computer consumes electricity even when the computer power is off. If the battery pack is fully charged, the battery will fully discharge in the following period of time:

Status	Discharge period
When power is off	Approx. 6 weeks
In sleep	Approx. 4 days
In hibernation	Approx. 7 days

First-time Operation

2 Attaching the pen (included) to the computer.

The tether prevents the pen (included) from falling accidentally.

- ① Pass one of the loops through the hole.

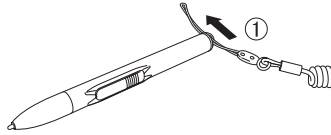

- ② Pass one of the loops through another loop.

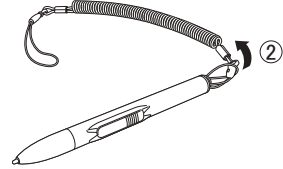

- ③ Thread the second loop on the tether through the hole as illustrated.

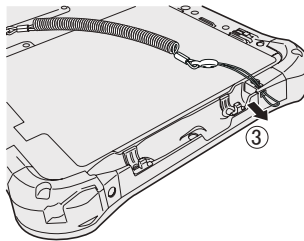

- ④ Pass the pen and tether through the second loop.

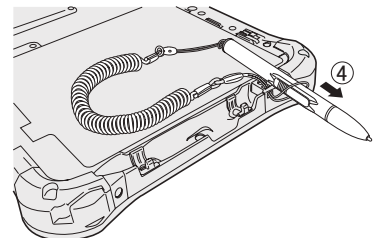

CAUTION

- Do not pull the tether with excessive force. The pen (included) may hit the computer, person's body or other objects when released.

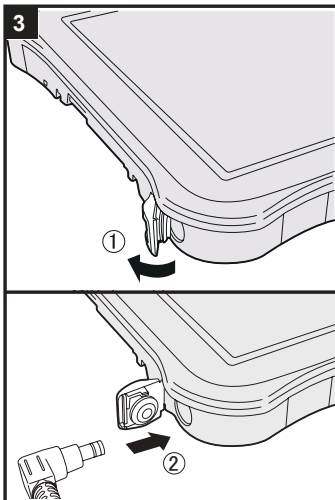



3 Connect your computer to a power outlet.

The battery charging starts automatically.

CAUTION

- Do not disconnect the AC adaptor until the first-time operation procedure is completed.
- When using the computer for the first time, do not connect any peripheral device (including wired LAN cable) except the battery pack and AC adaptor.
- **Handling the AC adaptor**
 - Problems such as sudden voltage drops may arise during periods of thunder and lightning. Since this could adversely affect your computer, an uninterruptible power source (UPS) is highly recommended unless running from the battery pack alone.

4 Turn on the computer.

Press and hold the power switch  (→ page 15) until the power indicator  (→ page 15) lights.

CAUTION

- Do not press the power switch repeatedly or do not hold the power switch for four seconds or longer.

5 <For MUI OS model>**Windows 8** Select language.**Windows 7** Select language and OS (32-bit or 64-bit).**CAUTION****Windows 7**

- Carefully choose your language because you cannot change it later. If you set a wrong language, you need to reinstall Windows.

Windows 8

- ① Select language on “Your display language” and touch [Next]. Follow the on-screen instructions.

Windows 7

- ① Select language and OS (32bit or 64bit) on “Select OS” screen and touch [OK].
The language setting will start by touching [OK] on the confirmation screen.
The language and OS setting will be completed in about 15 minutes.
- ② When termination screen is displayed, touch [OK] to turn off the computer.
- ③ Turn on the computer.

6 Setup Windows.

Follow the on-screen instructions.

- The computer restarts several times. Do not touch the screen or tablet buttons, and wait until the drive indicator  has turned off.
- After the computer is turned on, the screen remains black or unchanged for a while, but this is not a malfunction. Wait for a moment until the Windows setup screen appears.
- Setup of Windows will take approximately **Windows 8** 5 minutes / **Windows 7** 20 minutes.
Go to the next step, confirming each message on the display.
- **Windows 7** Follow the steps below.
 - ① When “Enable sensors” is displayed, touch [Enable this sensor].
 - ② When the [User Account Control] screen is displayed, touch [Yes].
 - ③ At the [Display Rotation Tool] confirmation screen, touch [Yes].

The computer restarts automatically, and the setting is enabled.
- **Windows 7** “Join a wireless network” screen may not appear.

You can set the Wireless Network after the setup of Windows is complete.

CAUTION

- You can change the user name, password, image and security setting after setup of Windows.
- Remember your password. If you forget the password, you cannot use Windows. Creating a password reset disk beforehand is recommended.
- Do not use the following words for user name: CON, PRN, AUX, CLOCK\$, NUL, COM1 to COM9, LPT1 to LPT9, @, &, space. In particular, if you create a user name (account name) that includes the “@” mark, a password will be requested at the log-on screen, even if no password has been set. If you try to log on without entering a password, “The user name or password is incorrect.” may be displayed and you will not be able to **Windows 8** sign in / **Windows 7** log on to Windows (→ page 36).
- Use standard characters as a computer name: numbers 0 through 9, uppercase and lowercase letters from A to Z, and the hyphen (-) character.
If the error message “The computer name is not valid” appears, check if characters other than the above are not entered. If the error message still remains on the display, set the key entry mode to English (“EN”) and enter characters.

7

Windows 8

Set the time zone, and then set the date and time.

- ① Open the Control Panel.
 1. Long touch any empty location on the Start screen.
 2. Touch [All apps] on the toolbar.
 3. Touch [Control Panel] under “Windows System”.
- ② Touch [Clock, Language, and Region] - [Date and Time].
- ③ Touch [Change time zone...].
- ④ Select the time zone, then click [OK].
- ⑤ Touch [Change date and time...], then set the date and time.

8

Create the recovery disc.

A recovery disc allows you to install OS and restore its factory default condition, in case, for example, the recovery partition of the flash memory is damaged. We recommend creating a recovery disc before you begin using the computer.

Refer to →  *Reference Manual* “Recovery Disc Creation Utility” about creating the disc.

NOTE

● PC Information Viewer

This computer periodically records the management information of the flash memory, etc. The maximum data volume for each record is 1024 bytes.

This information is only used for estimating the cause when the flash memory goes down by any possibility. They are never sent to outside via network nor used for any other purpose except for the purpose described the above.

To disable the function, add the check mark for [Disable the automatic save function for management information history] in [Hard Disk Status] of PC Information Viewer, and touch [OK].

(→  *Reference Manual* “Checking the Computer’s Usage Status”)

● **Windows 8** <For MUI OS model>

In the default settings, a shortcut icon for Korean language is on the Desktop screen. You may delete the icon if not necessary.

■ Before using wireless function

Windows 8

- ① Display “Charm” and touch  - [Change PC Settings] - [Wireless].
Set [Airplane mode] to [Off], and then;
set [Wi-Fi] in “Wireless device” to [On] (for wireless LAN).
set [Mobile broadband] in “Wireless device” to [On] (for wireless WAN).
set [GPS] in “Wireless device” to [On] (for wireless WAN).
set [Bluetooth] in “Wireless device” to [On] (for Bluetooth).

Windows 7

- ① Touch the Wireless Switch Utility icon to show the pop-up menu.
- ② Select ON for the device you want to enable.

■ To change the partition structure

You can shrink a part of an existing partition to create unallocated disk space, from which you can create a new partition. In the default setting, you can use a single partition.

① **Windows 8**

Open “Computer”. Long touch [Computer], then touch [Manage].

To open “Computer”, proceed as follows on the Start screen.

1. On the Start screen, flick from bottom side to inside of the screen.
2. Touch [All apps] on the toolbar.
3. Touch [Computer] under “Windows System”.

Windows 7

Touch  (Start) and long touch [Computer], then touch [Manage].

● A standard user needs to enter an administrator password.

- ② Touch [Disk Management].
- ③ Long touch the partition for Windows (“c” drive in the default setting), and touch [Shrink Volume].
 - The partition size depends on the computer specifications.
- ④ Input the size in [Enter the amount of space to shrink in MB] and touch [Shrink].
 - You cannot input a larger number than the displayed size.
 - To select [Reinstall to the System and OS partitions.] in installing OS (→ page 30),
Windows 8 70 GB^{*1} / **Windows 7** 60 GB or more is necessary for [Total size after shrink in MB].
- ⑤ Long touch [Unallocated] (the shrunk space in the step ④) and touch [New Simple Volume].
- ⑥ Follow the on-screen instructions to make the settings, and touch [Finish].
Wait until formatting is completed.

^{*1} For MUI OS model, 100 GB or more is necessary.

First-time Operation

NOTE

- You can create an additional partition using remaining unallocated space or newly creating unallocated space.
- To delete a partition, long touch the partition and touch [Delete Volume] in the step ③.

■ **Windows 8** <For MUI OS model>To select language



To select a language other than the one you have selected during the first-time operation, follow the steps below.

- ① Open the Control Panel.
 1. Long touch any empty location on the Start screen.
 2. Touch [All apps] on the toolbar.
 3. Touch [Control Panel] under “Windows System”.
- ② Touch [Clock, Language, and Region] - [Language] - [Add a language].
- ③ Select a language, and then touch [Add].

Depending on the region, two or more languages are selectable. Touch [Open] and select the desired language, and then touch [Add].
- ④ Touch [Option] for the language you want to use.
- ⑤ Touch [Make this the primary language].
- ⑥ Touch [Log off now].
- ⑦ Sign in to the Windows.

Turning On / Turning Off

Turning On

Press and hold the power switch  (→ page 15) until the power indicator  (→ page 15) lights.

NOTE

- Do not press the power switch repeatedly.
- The computer will forcibly be turned off if you press and hold the power switch for four seconds or longer.
- Once you turn off the computer, wait for ten seconds or more before you turn on the computer again.
- Do not perform the following operation until the drive indicator  turns off.
 - Connecting or disconnecting the AC adaptor
 - Pressing the power switch
 - Touching the tablet buttons, screen or external mouse/keyboard

Turning Off

① Shut down the computer.

Windows 8

1. Display “Charm” and touch .
2. Touch [Power] - [Shut down].

Windows 7

Touch  (Start) - [Shutdown].

NOTE

- **Windows 8**
To turn off the computer, proceed as follows.
 - ① Display “Charm” and touch  - [Change PC settings] - [General].
 - ② Touch [Restart now] under “Advanced startup”.
 - ③ Touch [Turn off your PC].

Precaution against Starting Up/Shutting Down

- Do not do the following
 - Connecting or disconnecting the AC adaptor
 - Pressing the power switch
 - Touching the screen or external mouse/keyboard

NOTE

- To conserve power, the following power saving methods are set at the time of purchase.
 - The screen automatically turns off after :
 - 10 minutes (when AC adaptor is connected) of inactivity
 - 5 minutes (when operating on battery power) of inactivity
 - The computer automatically enters sleep^{*1} after :
 - Windows 8** 30 minutes / **Windows 7** 20 minutes (when AC adaptor is connected) of inactivity
 - 15 minutes (when operating on battery power) of inactivity
- ^{*1} Refer to  *Reference Manual* “Sleep and Hibernation Functions” about resuming from sleep.

Handling and Maintenance

Operation environment

- Place the computer on a flat stable surface not subject to shock, vibration, and danger of dropping. Do not place the computer upright or turn it over. If the computer is exposed to an extremely strong impact, it may become damaged.
 - Operating environment
 - Temperature: Operation : -10 °C to 50 °C (IEC60068-2-1, 2)^{*1}
Storage : -20 °C to 60 °C
 - Humidity: Operation : 30% to 80% RH (No condensation)
Storage : 30% to 90% RH (No condensation)
- Even within the above temperature/humidity ranges, operation for a long time in extreme environments, smoking nearby, or operation in places where oil is used or where there is a lot of dust will result in the product deterioration and will shorten the product life.
- ^{*1} Do not expose the skin to this product when using the product in a hot or cold environment. (→ page 5)
- If the computer is wet in temperatures of 0 °C or below, freeze damage may occur. Make sure to dry off the computer in such temperatures.
- Do not place the computer in the following areas, otherwise the computer may be damaged.
 - Near electronic equipment. Image distortion or noise may occur.
 - In extremely high or low temperature.
 - As the computer can become hot during operation, keep it away from items that are sensitive to heat.

Handling cautions

This computer is designed to minimize shock to parts such as the LCD and the flash memory drive, but no warranty is provided against any trouble caused by shock. Be extremely careful when handling the computer.

- When carrying the computer:
 - Turn off the computer.
 - Remove all external devices, cables, Smart Cards and other protruding objects.
 - Do not drop or hit the computer against solid objects.
 - Do not grip the display part.
- When you board an airplane, take the computer with you and never put it in your checked luggage. When using the computer on airplane, follow the airline's instructions.
- When carrying a spare battery, put it in a plastic bag to protect its terminals.
- Avoid any harmful substances such as oil from getting into the touch pad. The pointer may not work correctly.
- Be careful not to get injured by dropping or getting hit when carrying the computer.
- Use only the included digitizer pen to touch the screen. Do not place any object on its surface and do not press down strongly with sharp-pointed or hard objects that may leave marks (e.g., nails, pencils and ball point pens).
- Do not use the screen when dust or dirt (e.g., oil) is on the screen. Otherwise foreign particles on the screen/digitizer pen can scratch the screen surface or obstruct the digitizer pen operation.
- Use the digitizer pen only for touching the screen. Using it for any other purpose may damage the digitizer pen and result in scratches on the screen.
- The digitizer uses electromagnetic induction and may not work properly near strong electrical field or magnetic field such as:
 - Near AM radio base station or relay station antennas
 - Near CRT displays that generate strong electromagnetic field noiseMove the digitizer away from such locations so it will work properly.
- The pointer cannot follow the digitizer pen movement if you move the digitizer pen too quickly.

■ When the battery indicator does not light on

The battery indicator may not light on even if the AC adaptor and the battery pack are correctly connected to the computer, due to the following reasons.

- The AC adaptor's protection function may be working. In this case, pull out the AC cord and wait for more than 1 minute before reconnecting the AC cord.

■ When using peripheral devices

Follow these instructions and the Reference Manual to avoid any damage to the devices. Carefully read the instruction manuals of the peripheral devices.

- Use the peripheral devices conforming to the computer's specifications.
- Connect to the connectors in the correct direction.
- If it is hard to insert, do not try forcibly but check the connector's shape, direction, alignment of pins, etc.
- If screws are included, fasten them securely.
- Remove the cables when you carry the computer. Do not pull the cables forcibly.

■ Preventing your computer from unauthorized use via wireless LAN/Bluetooth/Wireless WAN

<Only for model with wireless LAN/Bluetooth/Wireless WAN>

- Before using wireless LAN/Bluetooth/Wireless WAN, make the appropriate security settings such as data encryption.

■ Battery Recalibration

- The battery recalibration may take a long time due to the large battery capacity. This is not a malfunction.

<When performing "Battery Recalibration" after shutting down Windows>

- Full charge: Approximately 2.5 hours
- Complete discharge: Approximately 3 hours

When performing "Battery Recalibration" without shutting down Windows, it may take more time to charge / discharge.

■ Sensors

This computer is equipped with four sensors (acceleration sensor, gyro sensor, magnetic sensor, ambient light sensor), and you can use these sensors with any software that is compatible.

As the accuracy of each sensor output is dependent on the operating environment and other conditions, the results should only be used as a reference.

The acceleration sensor, gyro sensor, and magnetic sensor are located at the bottom left of the LCD. The detection results of each sensor may vary depending on how you are holding the computer, the application software you are using, and other factors.

● Automatic brightness adjustment

The computer is equipped with an automatic brightness adjustment function that adjusts the display screen based on the ambient light sensor. You can configure the automatic adjustment function as follows.

Windows 8

- ① Display "Charm" and touch  - [Change PC Settings] - [General] - [Screen] - [Adjust my screen brightness automatically].

Windows 7

- ① Touch  (Start) - [Control Panel] - [Hardware and Sound] - [Power Option].
- ② Touch [Change plan settings] for the power plan currently used.

Handling and Maintenance

- ③ Touch [Change advanced power settings] and double-touch [Display].
- ④ Double-touch [Enable adaptive brightness], make necessary settings, and touch [OK].
Set each item to ON, and the brightness of the screen display will adjust automatically.
The ambient light sensor is located at the top of LCD.
The ambient light cannot be detected properly if this area is obstructed or dirty.

● Magnetic sensor

The magnetic sensor on the computer operates by detecting geomagnetism. Therefore, the magnetic sensor may not function properly and its readings may be inaccurate, especially in the following environments.

- Inside or near steel structures such as buildings or bridges
- Inside or near automobiles, or near train power lines
- Near metallic furniture or appliances
- When the AC adaptor or other peripheral devices are brought closer to the computer
- Near magnets, speakers, or other objects with strong magnetic fields

The magnetic directions indicated by the magnetic sensor may not be accurate immediately after purchase or in environments with poor magnetic fields.

In such cases, turn on the computer and move it as follows.

- ① Hold the computer so that its screen side is facing upward and level.
- ② While keeping the computer level, rotate it 90 degrees or more clockwise.
- ③ Return the computer to position ①, and rotate it 90 degrees or more counterclockwise.
- ④ Return the computer to position ①.
- ⑤ Tilt the computer 90 degrees or more to the left so that the left side of the computer tilts down.
- ⑥ Return the computer to position ①, and tilt it 90 degrees or more to the right so that the right side of the computer tilts down.

CAUTION

- Hold the computer firmly when moving it. Strong shocks from dropping the computer may result in damage.
-

Maintenance

If drops of water or other stains get on the surface of the LCD panel, wipe them off immediately. Failure to do so may result in staining.

To clean the LCD panel

Use the soft cloth included with the computer. (For further information, refer to “Suggestions About Cleaning the LCD Surface” →  *Reference Manual* “Screen Input Operation”.)

To clean areas other than the LCD panel

Wipe with a soft dry cloth such as gauze. When using detergent, dip a soft cloth in water-diluted detergent and wring it thoroughly.

CAUTION

- Do not use benzene, thinner, or rubbing alcohol since it may adversely affect the surface causing discoloration, etc. Do not use commercially-available household cleaners and cosmetics, as they may contain components harmful to the surface.
- Do not apply water or detergent directly to the computer, since liquid may enter inside of the computer and cause malfunction or damage.

To clean inside of the dust cover

Approximately once a month, clean up inside of the dust cover by the following procedure.

- ① Turn off the computer and remove the AC adaptor.
- ② Turn over the computer, and remove the battery pack.
- ③ Remove the screw (A) and dust cover as illustrated below.

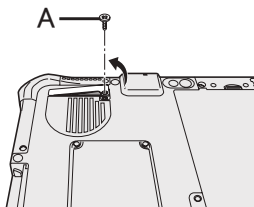

- ④ Clean up inside of the dust cover.
- ⑤ Set the dust cover, screw and battery pack.

Installing Software

Installing software will return the computer to the default condition. When you install the software, the flash memory data will be erased.

Back up important data to other media or an external hard disk before installation.

CAUTION

- Do not delete the Recovery Partition on the flash memory. The Recovery Partition is not available to store data.

To check the Recovery Partition, perform the following methods.

① Windows 8

Open "Computer". Long touch [Computer], then touch [Manage].

To open "Computer", proceed as follows on the Start screen.

1. On the Start screen, flick from right side to inside of the screen.
2. Touch [All apps] on the toolbar.
3. Touch [Computer] under "Windows System".

Windows 7

Touch  (Start) and long touch [Computer], then touch [Manage].

- A standard user needs to enter an administrator password.

② Touch [Disk Management].

NOTE

- You can use the following buttons instead of the keyboard.

 : F2 key (Default setting)

 : ↓ key

 : ↑ key

 : Enter key

 : Tab key

■ Flash memory Recovery

You can reinstall the OS that was pre-installed at the time of purchase (Windows 8 or Windows 7).

Preparation

- **Windows 8** <Only for model with TPM> Connect the external keyboard.
- Remove all peripherals.
- Connect the AC adaptor and do not remove it until installation is complete.

Windows 8

1 Perform "Remove everything and reinstall Windows".

① Display "Charm" and touch  - [Change PC settings] - [General].

② Touch [Get Started] under "Remove everything and reinstall Windows".

③ Select the option.

- Just remove my files

Perform the reinstallation of the Windows in a few moments (Approximately 20 minutes).

- Fully clean the drive

By fully cleaning, the deleted files can be not be recoverd easily and the security level will be increased. The processing time will be longer (Approximately 140 minutes).

Follow the on-screen instructions.

After the reinstallation, the computer will restart.

- Do not interrupt installation, for example by turning off the computer or other operation. Otherwise installation may become unavailable as Windows may not start up or the data may be corrupted.

2 Perform the “First-time Operation” (→ page 19).

NOTE

- The date and time, and the time zone may not be correct. Be sure to set them correctly.

3 Perform Windows Update.

4 <Only for model with TPM> Clear TPM.

- ① On the Start screen, flick from bottom side to inside of the screen and touch [All apps] on the toolbar.
- ② Touch [Run] under “Windows System”, input [tpm.msc] and touch [OK].
- ③ Touch [Clear TPM ...] under “Actions” on the right of the “TPM Manager on Local Computer” screen.
- ④ Touch [Restart] of the “Manage the TPM security hardware” screen.
The computer will restart.
- ⑤ When “TPM configuration change was requested to ...” is displayed, press **F12**.
Windows will start.
- ⑥ When “TPM is ready” appears, touch [Close].

Windows 7

1 Turn on the computer, and touch the top left corner of the screen several times while [Panasonic] boot screen is displayed.

The Setup Utility starts up.

- If the [Panasonic] boot screen is not displayed, turn on the computer while touching the top left corner of the screen.
- If the password is requested, enter the Supervisor Password.

2 Write down all of the contents of the Setup Utility and touch [Exit] and double-touch [Load Default Values].

At the confirmation message, touch [Yes].

3 Touch [Exit] and double-touch [Save Values and Reboot].

At the confirmation message, touch [Yes].

Computer will restart.

4 Touch the top left corner of the screen several times while [Panasonic] boot screen is displayed.

The Setup Utility starts up.

- If the password is requested, enter the Supervisor Password.

5 Select the [Exit] menu, then double-touch [Recovery Partition].

6 Touch [Reinstall Windows] and touch [Next].

The License Agreement screen appears.

7 Touch [YES].

The License Agreement screen appears.

8 Touch [Yes, I agree to the provisions above and wish to continue!] and touch [Next].

9 Select the setting and touch [Next].

- [Reinstall Windows to the whole Hard Disk to factory default.]
Select this option when you want to install Windows to the factory default. After installation, you can create a new partition. For how to create a new partition, refer to “To change the partition structure” (→ page 21).

Installing Software

- [Reinstall to the System and OS partitions.]^{*1}

Select this option when the flash memory has already been divided into several partitions. For how to create a new partition, refer to “To change the partition structure” (→ page 21).

You can keep the partition structure.

^{*1} This does not appear if Windows cannot be installed to the recovery partition and the area usable by Windows.

10 At the confirmation message, touch [YES].

11 <For localized OS model>

Select OS (32bit or 64bit) and touch [OK].

<For MUI OS model>

Select language and OS (32bit or 64bit), then touch [OK].

12 At the confirmation message, touch [YES].

Installation starts according to the instructions on the screen. (It will take approximately 20 minutes.)

- Do not interrupt installation, for example by turning off the computer or other operation. Otherwise installation may become unavailable as Windows may not start up or the data may be corrupted.

13 When Ending process screen is displayed, touch [OK] to turn off the computer.

14 Turn on the computer.

- If the password is requested, enter the Supervisor Password.

15 Perform the “First-time Operation” (→ page 19).

16 Start the Setup Utility and change the settings as necessary.

17 Perform Windows Update.

■ Using Recovery Disc

Use the Recovery Disc in the following conditions.

- You have forgotten the administrator password.
- Installation is not complete. The recovery partition in the flash memory may be broken.
- **Windows 7** <Only for Windows 7 downgrade model>
To change OS from Windows 7 to Windows 8, or vice versa.

NOTE

- **Windows 7** To change OS from 32 bit to 64 bit, or vice versa, install OS using the recovery partition in the flash memory.

Preparation

- Prepare the following items:
 - Recovery Disc (→  *Reference Manual* “Recovery Disc Creation Utility”)
 - USB DVD drive (optional) (refer to recent catalogs and other sources for information about the products available)
- Remove all peripherals (except for the USB DVD drive).
- Connect the AC adaptor and do not remove it until installation is complete.

1 Connect the DVD drive to the USB port.**2 Start the Setup Utility.****Windows 8**

- ① Display “Charm” and touch  - [Change PC settings] - [General].
- ② Touch [Restart now] under “Advanced startup”.
- ③ Touch [Troubleshoot] - [Advanced options] - [UEFI Firmware Settings] - [Restart].

Windows 7

Turn on the computer, and touch top left of the screen while [Panasonic] boot screen is displayed.

- If the [Panasonic] boot screen is not displayed, turn on the computer while touching top left of the screen.
- If the password is requested, enter the Supervisor Password.

3 Write down all of the contents of the Setup Utility and touch [Exit] and double-touch [Load Default Values].

At the confirmation message, touch [Yes].

4 Check the [UEFI Boot] setting of the Setup Utility.

[UEFI Boot] should be set to as follows.

When the recovery disc for Windows 8 is used: [Enabled]

When the recovery disc for Windows 7 is used: [Disabled]

5 Set the Recovery Disc into the DVD drive.**6 Touch [Exit] and double-touch [Save Values and Reboot].**

At the confirmation message, touch [Yes].

Computer will restart.

7 Touch top left of the screen while [Panasonic] boot screen is displayed.

The Setup Utility starts up.

- If the password is requested, enter the Supervisor Password.

8 Touch [Exit], then double-touch your DVD drive in [Boot Override].**9 Double-touch [Yes].**

The computer will restart.

10 Touch [Reinstall Windows] and touch [Next].**11 **Windows 8** At the confirmation message, touch [YES].****12 At the License Agreement screen, Touch [Yes, I agree to the provisions above and wish to continue!] and touch [Next].****13 When the recovery disc for Windows 8 is used, touch [Next].**

When the recovery disc for Windows 7 is used, select the setting and touch [Next].

- [Reinstall Windows to the whole Hard Disk to factory default.]
Select this option when you want to install Windows to the factory default. After installation, you can create a new partition. For how to create a new partition, refer to “To change the partition structure” (➔ page 21).

Installing Software

- [Reinstall to the System and OS partitions.]²
Select this option when the flash memory has already been divided into several partitions. For how to create a new partition, refer to “To change the partition structure” (→ page 21).
You can keep the partition structure.
² This does not appear if Windows cannot be installed to the recovery partition and the area usable by Windows.

14 At the confirmation message, touch [YES].

Installation starts according to the instructions on the screen. (It will take approximately 30 - 45 minutes.)

- Do not interrupt installation, for example by turning off the computer.
Otherwise installation may become unavailable as Windows may not start up or the data may be corrupted.

15 When Ending process screen is displayed, remove the Recovery Disc and DVD Drive.

Follow the on-screen instructions.

Some models may take approximately 40 minutes.

16 Perform the “First-time Operation” (→ page 19).

NOTE

- **Windows 8** The date and time, and the time zone may not be correct. Be sure to set them correctly.
-

17 Start the Setup Utility and change the settings as necessary.

18 Perform Windows Update.

19 **Windows 8** <Only for model with TPM> Clear TPM (→ page 29).

Troubleshooting (Basic)

Follow the instructions below when a problem has occurred. There is also an advanced troubleshooting guide in the “Reference Manual”. For a software problem, refer to the software’s instruction manual. If the problem persists, contact Panasonic Technical Support. You can also check the computer’s status in the PC Information Viewer





(→  *Reference Manual* “Troubleshooting (Advanced)”).

■ Starting Up



<p>Cannot start up. The power indicator or battery indicator is not lit.</p>	<ul style="list-style-type: none"> ● Connect the AC adaptor. ● Insert a fully charged battery. ● If a device is connected to the USB port, disconnect the device, or set [USB Port] or [Legacy USB Support] to [Disabled] in the [Advanced] menu of the Setup Utility. ● Turn off the concealed mode (→  <i>Reference Manual</i> “Setup Utility”). ● Check the [UEFI Boot] setting of the Setup Utility. [UEFI Boot] should be set to Windows 8 [Enabled] / Windows 7 [Disabled].
<p>The power is turned on but “Warming up the system” appears.</p>	<ul style="list-style-type: none"> ● The computer is warming up before start up. Wait for the computer to start up (the maximum waiting time will be displayed on the screen). If, “Cannot warm up the system” is displayed, the computer failed to warm up and does not start. In this case, turn off the computer, leave it in an environment of 5 °C or higher temperature for about an hour, and then turn on the power again.
<p>Cannot turn on the computer. The computer does not resume from sleep. (The battery indicator blinks green and orange alternately.)</p>	<ul style="list-style-type: none"> ● Leave it in an environment of 5 °C or higher temperature for about an hour, then turn on the power again.
<p>You have forgotten the password.</p>	<ul style="list-style-type: none"> ● Supervisor Password or User Password: Contact Panasonic Technical Support. ● Administrator password: <ul style="list-style-type: none"> • If you have a password reset disk, you can reset the administrator password. Set the disk and enter any wrong password, then follow the on-screen instructions and set a new password. • If you do not have a password reset disk, install (→ page 28) and set up Windows, and then set a new password.
<p>“Remove disks or other media. Press any key to restart” or a similar message appears.</p>	<ul style="list-style-type: none"> ● A floppy disk is in the drive and it does not contain system startup information. Remove the floppy disk and press any key. ● If a device is connected to the USB port, disconnect the device, or set [USB Port] or [Legacy USB Support] to [Disabled] in the [Advanced] menu of the Setup Utility. ● If the problem persists after removing the disk, it may be a flash memory failure. Contact Panasonic Technical Support.

Troubleshooting (Basic)



■ Starting Up

<p>Windows startup and operation is slow.</p>	<ul style="list-style-type: none"> ● Start the Setup Utility (→  <i>Reference Manual</i> “Setup Utility”) to return the Setup Utility settings (excluding the passwords) to the default values. Start the Setup Utility and make the settings again. (Note that the processing speed depends on the application software, so this procedure may not make Windows faster.) ● If you installed a resident software after purchase, turn off the residence.
<p>The date and time are incorrect.</p>	<ul style="list-style-type: none"> ● Make the correct settings. <ol style="list-style-type: none"> ① Open the Control Panel. <ul style="list-style-type: none"> Windows 8 1. On the Start screen, flick from bottom side to inside of the screen. 2. Touch [All apps] on the toolbar. 3. Touch [Control Panel] under “Windows System”. Windows 7 Touch  (Start) - [Control Panel]. ② Touch [Clock, Language, and Region] - [Date and Time]. ③ Touch [Change time zone...]. ④ Select the time zone, then touch [OK]. ⑤ Touch [Change date and time...], then set the date and time. <ul style="list-style-type: none"> ● If the problem persists, the internal clock battery may need to be replaced. Contact Panasonic Technical Support. ● When the computer is connected to LAN, check the date and time of the server. ● The 2100 A.D. or later year will not be correctly recognized on this computer.
<p>[Executing Battery Recalibration] screen appears.</p>	<ul style="list-style-type: none"> ● The Battery Recalibration was canceled before Windows was shut down last time. To start up Windows, turn off the computer by the power switch, and then turn on.
<p>[Enter Password] does not appear when resuming from sleep/hibernation.</p>	<ul style="list-style-type: none"> ● Select [Enabled] in [Password On Resume] in the [Security] menu of the Setup Utility (→  <i>Reference Manual</i> “Setup Utility”). ● The Windows password can be used instead of the password set in the Setup Utility. <ol style="list-style-type: none"> ① Open the Control Panel. <ul style="list-style-type: none"> Windows 8 1. On the Start screen, flick from bottom side to inside of the screen. 2. Touch [All apps] on the toolbar. 3. Touch [Control Panel] under “Windows System”. Windows 7 Touch  (Start) - [Control Panel]. ② Touch [User Accounts and Family Safety] - [Add or remove user accounts]. ③ Touch [System and Security] - [Power Option] - [Require a password when the computer wakes] and add a check mark for [Require a password].

■ Starting Up

Cannot resume.	<ul style="list-style-type: none"> ● One of the following operations may have been carried out. Press the power switch to turn on the computer. Data not saved will be lost. <ul style="list-style-type: none"> • In sleep mode, the AC adaptor or battery pack was disconnected, or a peripheral was connected or disconnected. • The power switch was pressed for four seconds or longer to forcibly turn off the computer. ● An error may occur when the computer automatically enters the sleep or hibernation mode while the screensaver is active. In this case, turn off the screensaver or change the pattern of the screensaver.
Other startup problems.	<ul style="list-style-type: none"> ● Start the Setup Utility (→  <i>Reference Manual</i> “Setup Utility”) to return the Setup Utility settings (excluding the passwords) to the default values. Start the Setup Utility and make the settings again. ● Remove all peripheral devices. ● Check to see if there was a disk error. <ol style="list-style-type: none"> ① Remove all peripheral devices including an external display. ② Open “Computer”. <ul style="list-style-type: none"> ● Windows 8 <ol style="list-style-type: none"> 1. On the Start screen, flick from bottom side to inside of the screen. 2. Touch [All apps] on the toolbar. 3. Touch [Computer] under “Windows System”. ● Windows 7 <ul style="list-style-type: none"> Touch  (Start) - [Computer]. ③ Long touch [Local Disk (C:)], and touch [Properties]. ④ Touch [Tools] - [Check Now...]. <ul style="list-style-type: none"> • A standard user needs to enter an administrator password. ⑤ Select the option in [Check disk options] and touch [Start]. ⑥ Touch [Schedule disk check] and restart the computer. ● Windows 7 <p>Connect the external keyboard and start the computer in Safe Mode, then check the error details. When the [Panasonic] boot screen disappears*¹ at startup, press and hold F8 until the Windows Advanced Options Menu is displayed. Select the Safe Mode and press Enter.</p> <p>*¹ When [Password on boot] is set to [Enabled] in the [Security] menu of the Setup Utility, [Enter Password] appears after the [Panasonic] boot screen disappears. As soon as you enter the password and press Enter, press and hold F8.</p>

■ Entering Password

Even after entering the password, password input screen is displayed again.	<p><Only if the external keyboard is connected></p> <ul style="list-style-type: none"> ● The computer may be in ten-key mode. <p>If the NumLk indicator  lights, press NumLk to disable the ten-key mode, and then input.</p> ● The computer may be in Caps Lock mode. <p>If the Caps Lock indicator  lights, press Caps Lock to disable the Caps Lock mode, and then input.</p>
---	--

Troubleshooting (Basic)

■ Entering Password

Cannot log on to Windows. (“The user name or password is incorrect.” is displayed.)

- The user name (account name) includes an “@” mark.
 - If another user account name exists:
Log on to Windows using another user account name, and delete the account name that includes “@”. Then create a new account name.
 - If no other account name exists:
You need to reinstall Windows (→ page 28).



■ Shutting down

Windows does not shut down.

- Remove the USB device and the ExpressCard.
- Wait one or two minutes. It is not a malfunction.

■ Display

No display.

- The external display is selected.
 - Windows 8**
 - ① Display “Charm” and touch  - .
 - ② Touch and select the display mode.
 - Windows 7**
 - ① Long touch the desktop, and then touch [Graphic Properties].
 - ② Select one of the application modes and touch [OK].
 - ③ Touch [Multiple Displays].
 - ④ Select the display in [Operating Mode].
 - ⑤ Touch [Apply].
 - ⑥ Touch [OK].
 - ⑦ If necessary, touch [General Settings], set the color depth, resolution, etc., and touch [OK].
- When using an external display,
 - Check the cable connection.
 - Turn on the display.
 - Check the settings of external display.
- The display is turned off by the power-saving function.
 - Windows 8**
Touch the screen.
 - Windows 7**
To resume, touch the screen.
- The computer entered sleep or hibernation by the power-saving function. To resume, press the power switch.



The screen is dark.

- The screen is darker when the AC adaptor is not connected. Open the Dashboard for Panasonic PC and adjust the brightness. As you increase the brightness, battery consumption increases. You can separately set the brightness for when the AC adaptor is connected and when not connected.
- Turn off the concealed mode (→  *Reference Manual* “Setup Utility”).

■ Display

The screen is disordered.	<ul style="list-style-type: none"> ● Changing the number of display colors and resolution may affect the screen. Restart the computer. ● Connecting/disconnecting an external display may affect the screen. Restart the computer. Under factory default settings, the brightness of the display screen will adjust automatically based on the ambient light detected by the ambient light sensor. You can adjust the settings for this sensor (→ page 25).
During Simultaneous display, one of the screens becomes disordered.	<ul style="list-style-type: none"> ● When using the Extended Desktop, use the same display colors for the external display as those used by the LCD. If you continue to experience problems, try changing the display. Long touch on the desktop, and touch [Graphics Properties...] - [Display]. ● Simultaneous display cannot be used until Windows startup is complete (during Setup Utility, etc.).
The external display does not work normally.	<ul style="list-style-type: none"> ● If the external display does not support the power saving function, it may not work normally when the computer enters the power saving mode. Turn off the external display.
Cannot rotate the display.	<ul style="list-style-type: none"> ● The application program currently running may not support the image rotation. Quit the program, and then try to rotate the image. This can ameliorate the status. ● When the automatic rotation is off, screen display does not rotate automatically.

■ Screen

The pointer does not work.	<ul style="list-style-type: none"> ● When using the external mouse, connect it correctly. ● Restart the computer using the external keyboard/mouse. ● If the computer does not respond to external keyboard/mouse commands, read “No response” (→ page 38).
Cannot point the correct position using the included digitizer pen.	<ul style="list-style-type: none"> ● Perform the screen calibration (→  <i>Reference Manual</i> “Screen Input Operation”). ● Use the included pen. ● On the Windows logon screen or the Welcome screen, you may not be able to point the correct position using the included digitizer pen. Use the external keyboard or the external mouse to log on. ● You may not be able to point the correct position using your finger after resuming from sleep or hibernation while the display is rotated. If this is the case, proceed as follows. <ol style="list-style-type: none"> ① Windows 8 <ol style="list-style-type: none"> 1. On the Start screen, flick from bottom side to inside of the screen, and touch [All apps] on the toolbar. 2. Touch [Run] under “Windows System”, input [c:\util\reset\reset.exe] and touch [OK]. ② Windows 7 <p>Touch  (Start) and input “c:\util\reset\reset.exe” in [Search programs and files], then press Enter.</p> ③ Touch [Yes] on the [User Account Control] screen. ④ Select [Disabled] and touch [OK]. ④ Touch [Yes] when you are prompted to restart the computer.

Troubleshooting (Basic)



■ Screen

<p>Cannot display “Charm” or difficult to display “Charm”.</p>	<ul style="list-style-type: none"> ● Delete the calibration data. <ol style="list-style-type: none"> ① Start Dashboard for Panasonic PC and touch [Basic] - [Touch Calibration]. ② Touch [Reset...] and follow the on-screen instructions.
--	--

■ On-screen Document

<p>Windows 7 The document of PDF format is not displayed.</p>	<ul style="list-style-type: none"> ● Install Adobe Reader. <ol style="list-style-type: none"> ① Log on to Windows as an administrator. ② Touch  (Start) and input “c:\util\reader\Pinstall.bat” in [Search Programs and files] then press Enter. ③ Update Adobe Reader to its latest version. If your computer is connected to the internet, start up Adobe Reader and touch [Help] - [Check for Updates...].
--	--

■ Others

<p>No response.</p>	<ul style="list-style-type: none"> ● Open Task Manager and close the software application that is not responding. ● An input screen (e.g., password input screen at startup) may be hidden behind another window. Touch the application icons at the bottom of the screen to check. ● Press the power switch for four seconds or longer to shut down the computer, and then press the power switch to turn it on. If the application program does not work normally, uninstall and reinstall the program. To uninstall, <ol style="list-style-type: none"> ① Open the Control Panel. <ul style="list-style-type: none"> Windows 8 1. On the Start screen, flick from bottom side to inside of the screen. 2. Touch [All apps] on the toolbar. 3. Touch [Control Panel] under “Windows System”. Windows 7 Touch  (Start) - [Control Panel]. ② Touch [Program] - [Uninstall a program].
<p>The recovery disc for Windows 8 in not functioning.</p>	<ul style="list-style-type: none"> ● Perform recovery using the recovery disc for Windows 7 first, and then perform recovery using the recovery disc for Windows 8.
<p>Cannot connect to a network.</p>	<ul style="list-style-type: none"> ● Set the device ([Wireless LAN] / [Bluetooth] / [Wireless WAN] of [Wireless Configuration]) to [Enabled] in the [Advanced] menu of the Setup Utility (Wireless Configuration). <ul style="list-style-type: none"> Windows 8 ● Display “Charm” and touch  - [Change PC Settings] - [Wireless]. Set [Airplane mode] to [Off], and then; set [Wi-Fi] in “Wireless device” to [On] (for wireless LAN). set [Mobile broadband] in “Wireless device” to [On] (for wireless WAN). set [GPS] in “Wireless device” to [On] (for wireless WAN). set [Bluetooth] in “Wireless device” to [On] (for Bluetooth).

LIMITED USE LICENSE AGREEMENT

THE SOFTWARE PROGRAM(S) (“PROGRAMS”) FURNISHED WITH THIS PANASONIC PRODUCT (“PRODUCT”) ARE LICENSED ONLY TO THE END-USER (“YOU”), AND MAY BE USED BY YOU ONLY IN ACCORDANCE WITH THE LICENSE TERMS DESCRIBED BELOW. YOUR USE OF THE PROGRAMS SHALL BE CONCLUSIVELY DEEMED TO CONSTITUTE YOUR ACCEPTANCE OF THE TERMS OF THIS LICENSE.

Panasonic Corporation has developed or otherwise obtained the Programs and hereby licenses their use to you. You assume sole responsibility for the selection of the Product (including the associated Programs) to achieve your intended results, and for the installation, use and results obtained therefrom.

LICENSE

- A. Panasonic Corporation hereby grants you a personal, non-transferable and non-exclusive right and license to use the Programs in accordance with the terms and conditions stated in this Agreement. You acknowledge that you are receiving only a LIMITED LICENSE TO USE the Programs and related documentation and that you shall obtain no title, ownership nor any other rights in or to the Programs and related documentation nor in or to the algorithms, concepts, designs and ideas represented by or incorporated in the Programs and related documentation, all of which title, ownership and rights shall remain with Panasonic Corporation or its suppliers.
- B. You may use the Programs only on the single Product which was accompanied by the Programs.
- C. You and your employees and agents are required to protect the confidentiality of the Programs. You may not distribute or otherwise make the Programs or related documentation available to any third party, by time-sharing or otherwise, without the prior written consent of Panasonic Corporation.
- D. You may not copy or reproduce, or permit to be copied or reproduced, the Programs or related documentation for any purpose, except that you may make one (1) copy of the Programs for backup purposes only in support of your use of the Programs on the single Product which was accompanied by the Programs. You shall not modify, or attempt to modify, the Programs.
- E. You may transfer the Programs and license them to another party only in connection with your transfer of the single Product which was accompanied by the Programs to such other party. At the time of such a transfer, you must also transfer all copies, whether in printed or machine readable form, of every Program, and the related documentation, to the same party or destroy any such copies not so transferred.
- F. You may not remove any copyright, trademark or other notice or product identification from the Programs and you must reproduce and include any such notice or product identification on any copy of any Program.

YOU MAY NOT REVERSE ASSEMBLE, REVERSE COMPILE, OR MECHANICALLY OR ELECTRONICALLY TRACE THE PROGRAMS, OR ANY COPY THEREOF, IN WHOLE OR IN PART.

YOU MAY NOT USE, COPY, MODIFY, ALTER, OR TRANSFER THE PROGRAMS OR ANY COPY THEREOF, IN WHOLE OR IN PART, EXCEPT AS EXPRESSLY PROVIDED IN THE LICENSE.

IF YOU TRANSFER POSSESSION OF ANY COPY OF ANY PROGRAM TO ANOTHER PARTY, EXCEPT AS PERMITTED IN PARAGRAPH E ABOVE, YOUR LICENSE IS AUTOMATICALLY TERMINATED.

LIMITED USE LICENSE AGREEMENT

TERM

This license is effective only for so long as you own or lease the Product, unless earlier terminated. You may terminate this license at any time by destroying, at your expense, the Programs and related documentation together with all copies thereof in any form. This license will also terminate effective immediately upon occurrence of the conditions thereof set forth elsewhere in this Agreement, or if you fail to comply with any term or condition contained herein. Upon any such termination, you agree to destroy, at your expense, the Programs and related documentation together with all copies thereof in any form.

YOU ACKNOWLEDGE THAT YOU HAVE READ THIS AGREEMENT, UNDERSTAND IT AND AGREE TO BE BOUND BY ITS TERMS AND CONDITIONS. YOU FURTHER AGREE THAT IT IS THE COMPLETE AND EXCLUSIVE STATEMENT OF THE AGREEMENT BETWEEN US, WHICH SUPERSEDES ANY PROPOSAL OR PRIOR AGREEMENT, ORAL OR WRITTEN, AND ANY OTHER COMMUNICATIONS BETWEEN US, RELATING TO THE SUBJECT MATTER OF THIS AGREEMENT.

Specifications

This page provides the specifications for the basic model.
The model number is different according to the unit configuration.

- To check the model number:
Check the bottom of the computer or the box the computer came in at the time of purchase.
- To check CPU speed, memory size and the flash memory drive size:
Run the Setup Utility (→  *Reference Manual* "Setup Utility") and select [Information] menu.
[Processor Speed]: CPU speed, [Memory Size]: Memory size, [Hard Disk]: Flash Memory drive size

■ Main Specifications

Model No.	FZ-G1AAAZXBE	
CPU	Intel® Core™ i5-3437U Processor (3 MB ^{*1} cache, up to 2.9 GHz) with Intel® Turbo Boost Technology	
Chipset	Mobile Intel® QM77 Express Chip set	
Video controller	Built-in Chip Set	
Memory ^{*1*2}	4 GB	
Video Memory ^{*1*3}	Windows 8 UMA 1664 MB Max. Windows 7 UMA <32-bit> 1544 MB Max. <64-bit> 1696 MB	
Storage ^{*4}	Flash memory drive : 128 GB	
	Windows 8 Approx. 10 GB is used as a partition with flash memory recovery tools. (Users cannot use this partition.) Approx. 1 GB is used as a partition with system tools. (Users cannot use this partition.) Windows 7 Approx. 20 GB is used as a partition with flash memory recovery tools. (Users cannot use this partition.) Approx. 300 MB is used as a partition with system tools. (Users cannot use this partition.)	
Display Method	10.1 WUXGA type	
Internal LCD ^{*5}	65,536/16,777,216 colors (1920 × 1200 dots)	
External Display (HDMI) ^{*6}	65,536/16,777,216 colors (1920 x 1200 dots Max.)	
Wireless LAN ^{*7}	Intel® Centrino® Advanced-N 6235 (→ page 43)	
Bluetooth ^{*8}	→ page 43	
Wireless WAN ^{*9}	Sierra Wireless™ MC8305 (→ page 44)	
LAN ^{*10}	IEEE 802.3 10Base-T/IEEE 802.3u 100Base-TX/IEEE 802.3ab 1000Base-T	
Sound	WAVE and MIDI playback, Intel® High Definition Audio subsystem support, Monaural speaker	
Security Chip	TPM (TCG V1.2 compliant) ^{*11}	
Camera	Front	1280 × 720 dots, 30 fps (Video), Monaural Microphone
	Rear ^{*12}	1280 × 720 dots, 30 fps (Video) / 2048 x 1536 dots (Still)
Sensor	Ambient light sensor	Equipped
	Magnetic sensor	
	Gyro sensor	
	Acceleration sensor	

Specifications

■ Main Specifications

Card Slot	Smart Card ^{*13}	x 1	
	micro SD Memory Card ^{*14}	x 1	
Interface	USB port 3.0 x 1, 2.0 x 1 ^{*15} , Serial Port (Dsub 9-pin male) ^{*16} , LAN port (RJ-45) ^{*10} , HDMI Port (Type A) ^{*17} , Expansion Bus Connector, Headset (Miniature jack, 3.5 DIA / Headphone: Impedance 32 Ω, Output Power 4 mW × 2, Stereo / Microphone: Monaural Input) ^{*18}		
Pointing Device	Digitizer + Multi touch (Capacitive) (Anti-Reflection, Digitizer pen (included) touch capable)		
Power Supply	AC adaptor or Battery pack		
AC Adaptor ^{*19}	Input: 100 V to 240 V AC, 50 Hz/60 Hz, Output: 16 V DC, 4.06 A		
Battery Pack	Li-ion 10.8 V, 4400 mAh (typ.), 4100 mAh (min.)		
Operating Time ^{*20}	Approx. 8 hours		
Charging Time ^{*21}	Power on	Approx. 3 hours	
	Power off	Approx. 2.5 hours	
Power Consumption ^{*22}	Approx. 30 W ^{*23} / Approx. 60 W (maximum when recharging in the ON state)		
Physical Dimensions (W × D × H)	270 mm × 188 mm × 19 mm		
Weight	Approx. 1.1 kg		
Environment	Operating	Temperature	-10 °C to 50 °C (IEC60068-2-1, 2) ^{*24}
		Humidity	30% to 80% RH (No condensation)
	Storage	Temperature	-20 °C to 60 °C
		Humidity	30% to 90% RH (No condensation)

■ Software

Base OS	Windows® 8 Pro 64-bit	Windows® 7 Professional 32-bit Service Pack 1 / Windows® 7 Professional 64-bit Service Pack 1
Installed OS ^{*25}	Windows® 8 Pro 64-bit	Windows® 7 Professional 32-bit Service Pack 1 (downgraded to Windows® 7) ^{*26} / Windows® 7 Professional 64-bit Service Pack 1 (downgraded to Windows® 7) ^{*26}

■ Software

Pre-installed Software ^{*25}	Adobe Reader, PC Information Viewer, Battery Recalibration Utility, Hand Writing Utility, Infineon TPM Professional Package ^{*11 *27} , Dashboard for Panasonic PC, Recovery Disc Creation Utility, Power Plan Extension Utility, Camera Utility, Manual Selector, Bluetooth Stack for Windows by TOSHIBA	
	Wireless Toolbox, Camera for Panasonic PC	Wireless Switch Utility, Wireless Connection Disable Utility ^{*27} , Quick Boot Manager, Software Keyboard
	Aptio Setup Utility, PC-Diagnostic Utility, Hard Disk Data Erase Utility ^{*28}	

■ Wireless LAN^{*7}

Data Transfer Rates	IEEE802.11a: 54/48/36/24/18/12/9/6 Mbps (automatically switched) ^{*29} IEEE802.11b: 11/5.5/2/1 Mbps (automatically switched) ^{*29} IEEE802.11g: 54/48/36/24/18/12/9/6 Mbps (automatically switched) ^{*29} IEEE802.11n ^{*30} : (HT20) GI ^{*31} = 400ns: 150/130/115/86/72/65/57/43/28/21/14/7 Mbps (automatically switched) ^{*29} GI ^{*31} = 800ns: 130/117/104/78/65/58/52/39/26/19/13/6 Mbps (automatically switched) ^{*29} (HT40) GI ^{*31} = 400ns: 300/270/240/180/150/135/120/90/60/45/30/15 Mbps (automatically switched) ^{*29} GI ^{*31} = 800ns: 270/243/216/162/135/121/108/81/54/40/27/13 Mbps (automatically switched) ^{*29}
Standards Supported	IEEE802.11a / IEEE802.11b / IEEE802.11g / IEEE802.11n
Transmission method	OFDM system, DSSS system
Wireless Channels Used	IEEE802.11a : Channels 36/40/44/48/52/56/60/64/100/104/108/112/116/120/124/128/132/136/140 IEEE802.11b / IEEE802.11g : Channels 1 to 13 IEEE802.11n : Channels 1-13/36/40/44/48/52/56/60/64/100/104/108/112/116/120/124/128/132/136/140
RF Frequency Band	IEEE802.11a : 5.18 GHz - 5.32 GHz, 5.5 GHz - 5.7 GHz IEEE802.11b / IEEE802.11g : 2.412 GHz - 2.462 GHz IEEE802.11n : 2.412 GHz - 2.462 GHz, 5.18 GHz - 5.32 GHz, 5.5 GHz - 5.7 GHz

■ Bluetooth^{*8}

Bluetooth Version	4.0
	Classic mode / Low Energy mode
Transmission method	FHSS system
Wireless Channels Used	Channels 1 to 79 / Channels 0 to 39
RF Frequency Band	2.402 GHz - 2.480 GHz

Specifications

■ Wireless WAN^{*9}

Data Communication	HSUPA	Category 6, 5.7 Mbps
	HSUPA (HSPA+)	Category 10, 14.4 Mbps
	UMTS	3GPP Release 6
	EDGE/ GPRS	MultiSlot Class 10 Circuit Switched Data
Other Features	SMS	Mobile Originated SMS (MO-SMS) Mobile Terminated SMS (MT-SMS)
	FAX	No Support
	Voice	No Support
SIM		1.8/3V SIM Support

^{*1} 1 MB = 1,048,576 bytes/1 GB = 1,073,741,824 bytes

^{*2} Memory size of the factory default depends on the model.

^{*3} A segment of the main memory is allotted automatically depending on the computer's operating status. The size of the Video Memory cannot be set by the user.

^{*4} 1 MB = 1,000,000 bytes / 1 GB = 1,000,000,000 bytes. Your operating system or some application software will report as fewer GB.

^{*5} A 16,777,216 color display is achieved by using the dithering function.

^{*6} Selectable resolution depends on the specifications of the external display. Display may be impossible using some connected external displays.

^{*7} Only for model with wireless LAN.

^{*8} Only for model with Bluetooth.

^{*9} Only for model with wireless WAN.

The specifications may differ depending on the models.

^{*10} Only for model with LAN.

^{*11} Only for model with TPM.

For information on TPM, **Windows 8** on the Start screen, touch the [Manual Selector] tile, and select "Installation Manual for Trusted Platform Module (TPM)" / **Windows 7** Double-touch [Manual Selector] on the desktop, and select "Installation Manual for Trusted Platform Module (TPM)".

^{*12} Only for model with Rear Camera.

^{*13} Only for model with Smart Card slot.

^{*14} Only for model with micro SD memory card slot.

Operation has been tested and confirmed using Panasonic micro SD Memory Card with a capacity of up to 2 GB, Panasonic micro SDHC Memory Card with a capacity of up to 32 GB, and Panasonic micro SDXC Memory Card with a capacity of up to 64 GB.

Operation on other SD equipment is not guaranteed.

^{*15} Does not guarantee operation of all USB-compatible peripherals.

USB 2.0 port : Only for model with USB 2.0 port

^{*16} Only for model with serial port. To connect the serial device, the serial conversion cable (included) is necessary.

^{*17} Does not guarantee operation of all HDMI-compatible peripherals.

^{*18} Applicable plug for headsets are as follows.

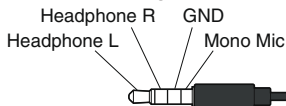

^{*19} The AC adaptor is compatible with power sources up to 240 V AC adaptor.

The unit for North America (identified by the suffix 'M' on the model number) is supplied with a 125 V AC compatible AC cord.

^{*20} Measured at LCD brightness: 60 cd/m²

Varies depending on the usage conditions, or when an optional device is attached.

^{*21} Varies depending on the usage conditions.

20-M-1-1

- *22 Approx. 0.5 W when the battery pack is fully charged (or not being charged) and the computer is OFF. Even when the AC adaptor is not connected to the computer, power is consumed (Max. 0.3 W) simply by having the AC adaptor plugged into an AC outlet.
- *23 Rated power consumption 23-E-1
- *24 Do not expose the skin to this product when using the product in a hot or cold environment. (→ page 5)
When using in hot or cold environment, some peripherals and battery pack may fail to work properly. Check the operation environment of the peripherals.
Using this product continuously in a hot environment will shorten the product life. Avoid use in these types of environments.
When using in low temperature environment, startup may become slow or battery operation time may become short. The computer consumes power when the flash memory is warming up during startup. Therefore, if you are using battery power and the remaining power is low, the computer may not start up.
- *25 Operations of this computer are not guaranteed except for the pre-installed OS and the OS which is installed by using the flash memory recovery and the recovery disc.
- *26 This system is preinstalled with Windows® 7 Professional software and also comes with a license for Windows 8 Pro software. You may only use one version of the Windows software at a time. Switching between versions will require you to uninstall one version and install the other version.
- *27 Must be installed before use.
- *28 Perform on the recovery disc. **Windows 7** Alternatively perform on the flash memory recovery.
- *29 It does not correspond to IEEE802.11a+b+g+n standards.
Actual speeds may differ.
- *30 Available when set to "WPA-PSK", "WPA2-PSK" or "none".
- *31 Only available when HT40 enabled by the computer and access point which associated supports HT40.

Standard Limited Warranty

Panasonic System Communications Company Europe

Panasonic System Communications Company Europe (referred to as “Panasonic”) will repair this product (other than software, which is treated in a different section of this warranty) with new or refurbished parts, from the date of original purchase in the event of a defect in materials or workmanship. This warranty only applies to new Panasonic Toughbooks purchased in the EEA and Switzerland and Turkey.

Panasonic (or its authorised Service Provider) target to repair your equipment within 48 hours from its receipt in our service centre.

Additional charges may apply for shipment to countries outside of the European Union. Panasonic will use all reasonable endeavours to ensure this service.

This warranty only covers failures due to defects in materials or workmanship which occur during normal use for the applicable Service Agreement Period listed below. In the event that any product (or part thereof) is replaced, Panasonic shall transfer ownership of the replacement product (or part) to the customer and the customer shall transfer ownership of the replaced product (or part) to Panasonic.

Service Agreement Period - from original date of purchase

- Toughbooks (and every accessory included in the original packaging except the battery) - 3 years
- Toughpads (and every accessory included in the original packaging except the battery) - 3 years
- Accessories included in the original package - 3 years
- Additional peripherals manufactured by Panasonic (including media bay devices such as CD-Rom drives) - 1 year
- Batteries - 6 months. Panasonic Warranty covers the battery for six months. A battery is considered good if it maintains 50% of its charge capacity during the warranty period. If a battery is returned under this contract and testing determines that it has charge capacity greater than 50%, the battery will be returned with an invoice for the retail purchase price of a new battery.

This warranty is extended solely to the original purchaser. A purchase receipt or other proof of date of original purchase will be required before warranty performance is rendered.

Limits and Exclusions:

This warranty does not cover and shall be void for:

- Broken or cracked LCD screen.
- Defective pixel in notebook displays and LCD screens within 0.002%
- Damage that is attributable to fire, theft or acts of God.
- Damage caused by environmental influences (electrical storms, magnetic fields etc.).
- Damage which has not been caused during normal operation
- Repair of damage that is cosmetic only or does not affect product functionality such as wear and tear, scratches and dents.
- Failures caused by products not supplied by Panasonic.
- Failures resulting from alteration, accidental damage, casualty, misuse, abuse or neglect.
- Introduction of liquid or other foreign matter into the unit.
- Improper installation, operation or maintenance.
- Improper connections with peripherals.
- Maladjustment of consumer controls such as function settings.
- Modification or service by anyone other than Panasonic or its approved Service Providers.
- Products used as short term rental or leased equipment.
- Products whose serial number has been removed making the unit warranty condition impossible to clearly determine.

THIS PRODUCT IS NOT INTENDED FOR USE AS, OR AS PART OF, NUCLEAR EQUIPMENT/SYSTEMS, AIR TRAFFIC CONTROL EQUIPMENT/SYSTEMS, OR AIRCRAFT COCKPIT EQUIPMENT/SYSTEMS¹. PANASONIC WILL NOT BE RESPONSIBLE FOR ANY LIABILITY RESULTING FROM THE USE OF THIS PRODUCT ARISING OUT OF THE FOREGOING USES.

¹ AIRCRAFT COCKPIT EQUIPMENT/SYSTEMS include Class2 Electrical Flight Bag (EFB) Systems and Class1 EFB Systems when used during critical phases of flight (e.g., during take-off and landing) and/or mounted on to the aircraft. Class1 EFB Systems and 2 EFB Systems are defined by FAA: AC (Advisory Circular) 120-76A or JAA: JAA TGL (Temporary Guidance Leaflets) No.36.

There are no other express warranties except as listed above.

We strongly recommend that customers backup their data before sending back their unit to an Authorised Service Provider.

Panasonic shall not be liable for loss of data or other incidental or consequential damages resulting from the use of this product, or arising out of any breach of this warranty. All express and implied warranties, including the warranties of satisfactory quality and fitness for a particular purpose are limited to the applicable warranty period set forth above. Panasonic shall not be liable for any indirect, special or consequential loss or damage (including without limitation any loss of profits) arising from the use of this product or for any breach of this warranty.

This limited warranty gives you specific legal rights, and you may have other rights that vary from country to country. You must consult the applicable country laws for a full determination of your rights. This limited warranty is in addition to, and does not affect any rights arising out of any contract of sale or by statute.

Panasonic System Communications Company Europe

Data Storage Media

Data Storage Media is the media on which the Operating System, drivers and programs originally installed by Panasonic on the main unit are stored. This media is originally provided with the unit.

Panasonic warrants to you only that the disc(s) or other media on which the Programs are furnished will be free from defects in material and workmanship under normal use for a period of sixty (60) days from the date of delivery thereof to you, as evidenced by your purchase receipt.

This is the only warranty Panasonic makes to you. Panasonic does not warrant that the functions contained in the Programs will meet your requirements or that the operation of the Programs will be uninterrupted or error free.

Panasonic's entire liability and your exclusive remedy under this warranty shall be limited to the replacement of any defective disk or other media which is returned to Panasonic's authorized Service Centre, together with a copy of the purchase receipt, within the aforesaid warranty period.

Panasonic shall have no obligation for any defects in the disk(s) or other media on which the Programs are furnished resulting from your storage thereof, or for defects that have been caused by operation of the disk(s) or other media otherwise than on the Product or in the environment conditions other than those specified by Panasonic by alteration, accident, misuse, abuse, neglect, mishandling, misapplication, installation, maladjustment of consumer controls, improper maintenance, modification or damage that is attributable to acts of God. In addition, Panasonic shall have no obligation for any defects in the disk(s) or other media if you have modified, or attempted to modify any Program.

Duration of implied warranties, if any is limited to sixty (60) days.

Pre-installed software

Pre-installed software means the software shipped pre-loaded by Panasonic, not that loaded by any third party or selling agent.

Standard Limited Warranty

Panasonic and its suppliers makes no warranty, either express, implied or statutory, with respect to software provided with the Product and licensed to Purchaser, its quality, performance, merchantability, or fitness for a particular purpose. Panasonic does not warrant that the functions contained in the software will be uninterrupted or error free. Panasonic assumes no risk of and shall not in any case be liable for any damages, including, without limitation, any special, incidental, consequential, or punitive damages arising from breach of warranty or contract, negligence or any other legal theory, including, without limitation loss of goodwill, profits or revenue, loss of use of the Programs or Products or any associated equipment, cost of capital, cost of any substitute equipment, facilities, or services, downtime costs, or claims of any party dealing with such damages.

Some countries do not allow the exclusion or limitation of incidental or consequential damages, or limitations on how long an implied warranty lasts, so the above limitations or exclusions may not apply to you.

This limited warranty gives you specific legal rights and you may also have other rights that vary from country to country. You must consult applicable country laws for a full determination of your rights.

Contacts

Address

Panasonic System Communications Company Europe
Panasonic Manufacturing U.K. Ltd.
Service Centre Building B4,
Wyncliffe Road, Pentwyn Industrial Estate, Cardiff,
United Kingdom
CF23 7XB

Web page

<http://www.toughbook.eu/>

Helpdesk

English speaking service	+44 (0) 8709 079 079
French speaking service	+33 (0) 1 47 91 64 99
German speaking service	+49 (0) 1805 410 930
Italian speaking service	+39 (0) 848 391 999
Spanish speaking service	+34 (0) 901 101 157
E-mail address	toughbooksupport@eu.panasonic.com
Czech speaking service	+420 (0) 800 143234
Hungarian speaking service	+36 (0) 6800 163 67
Polish speaking service	+48 (0) 800 4911558
Romanian speaking service	+40 (0) 800 894 743
Slovakian speaking service	+421 (0) 800 42672627
E-mail address	toughbooksupport@csg.de

Payments

toughbookservicepayments.cardiff@eu.panasonic.com

Panasonic Corporation

Osaka, Japan

Importer's name & address pursuant to the EU legislation.

**Panasonic System Communications Company Europe, Panasonic Marketing
Europe GmbH**

Hagenauer Straße 43

65203 Wiesbaden

Germany